

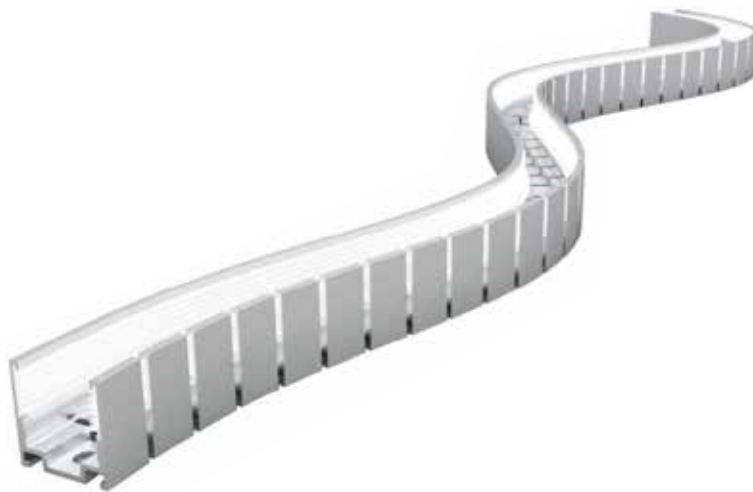

# AQUEON MOUNTING PROFILES

SPECIFICATION SHEET



# Aluminum Profile



High quality 6063 Aluminum with a low profile, lightweight, and warp/corrosion resistant design. The profile is designed to last in extreme environments and tested for weather resistance in accordance to IEC 68-2-11.

Please refer to the application installation Instructions.

## Dimension: inches

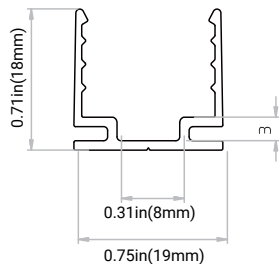

Tolerance:  $\pm 0.008 (\pm 0.2\text{mm})$

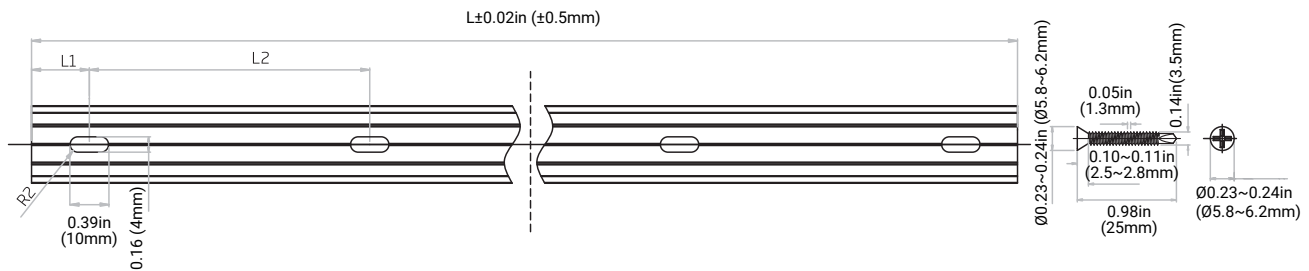
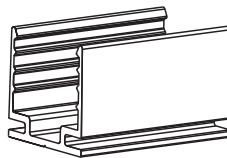

**Note:**

1. L1 refers to mounting holes.
2. L2 refers to mounting holes centers.

| Item Code | Standard Length | L1            | L2           | Slotted Hole Dimensions | Number of Holes |
|-----------|-----------------|---------------|--------------|-------------------------|-----------------|
| 053001    | 1.38in /35mm    | 0.69in/17.5mm | /            | 0.16x0.39in/4x10mm      | 1               |
| 053000    | 39.37in/1000mm  | 3.93in/100mm  | 7.87in/200mm | 0.16x0.39in/4x10mm      | 5               |

Specifications sheets are subject to change without notification.

# Flange Aluminum Profile



Flange Aluminum mounting profile for recessed applications, constructed with 6063 Aluminum. The Flange Aluminum Profile easily fits inside a mounting groove, simplifying installation. The profile is designed to last in extreme environments and tested for weather resistance in accordance to IEC 68-2-11.

Please refer to the application installation Instructions.

## Dimension: inches

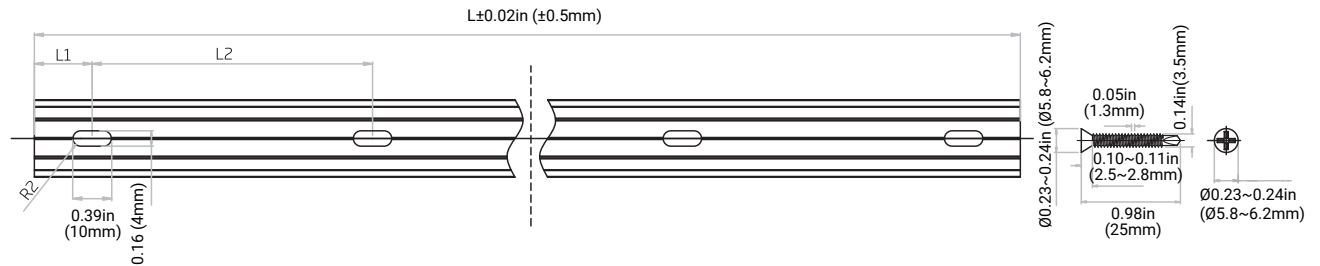
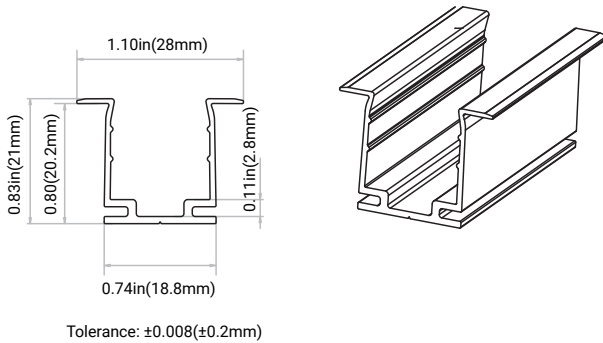

**Note:**

1. L1 refers to mounting holes.
2. L2 refers to mounting holes centers.

| Item Code | Standard Length | L1            | L2           | Slotted Hole Dimensions | Number of Holes |
|-----------|-----------------|---------------|--------------|-------------------------|-----------------|
| 053003    | 1.38in/35mm     | 0.69in/17.5mm | /            | 0.16x0.39in/4x10mm      | 3               |
| 053002    | 39.37in/1000mm  | 3.93in/100mm  | 7.87in/200mm | 0.16x0.39in/4x10mm      | 5               |

Specifications sheets are subject to change without notification.

# Thickened Plastic Profile

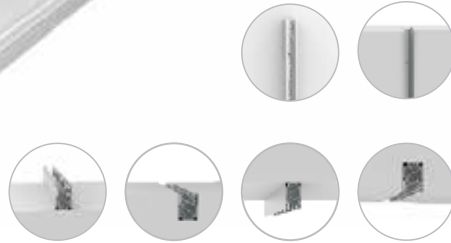

Plastic Profile is 0.12in(3mm) thick. The profile is rust, corrosion, fracture, salt water and pool chemical resistant.

Please refer to the application installation Instructions.

## Dimension: inches

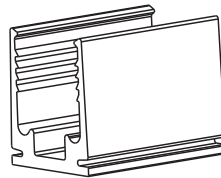
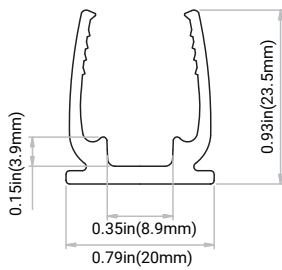

Tolerance:  $\pm 0.011\text{in}(\pm 0.3\text{mm})$

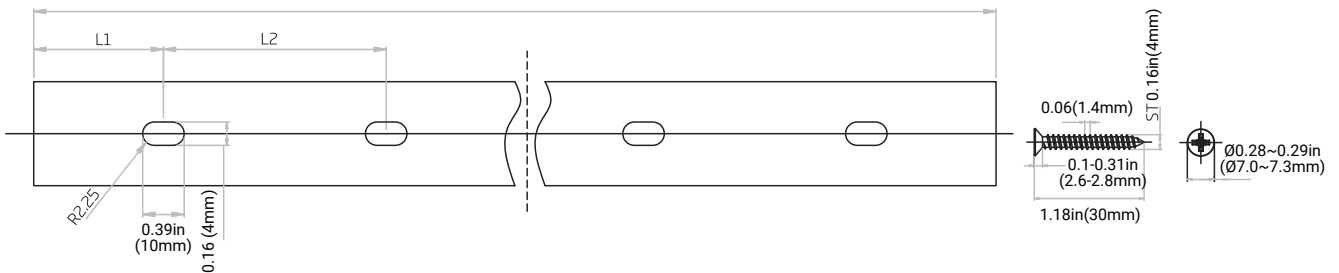

**Note:**

1. L1 refers to mounting holes.
2. L2 refers to mounting holes centers.

| Item Code | Standard Length | L1            | L2           | Slotted Hole Dimensions | Number of Holes |
|-----------|-----------------|---------------|--------------|-------------------------|-----------------|
| 053005    | 1.38in/35mm     | 0.69in/17.5mm | /            | 0.16x0.39in/4x10mm      | 1               |
| 053004    | 39.37in/1000mm  | 3.93in/100mm  | 7.87in/200mm | 0.16x0.39in/4x10mm      | 5               |

Specifications sheets are subject to change without notification.

# Internal Serrated Aluminum Profile



The Integral elastic serrated tape is a frictionless and simple to maintain mounting profile. It can stand a maximum of 50 times the LED Strip's weight in temperatures of -4~158°F (-20~70°C) and is easy to install and dismantle. The profile is designed to last in extreme environments and tested for weather resistance in accordance to IEC 68-2-11.

Please refer to the application installation Instructions.

## Dimension: inches

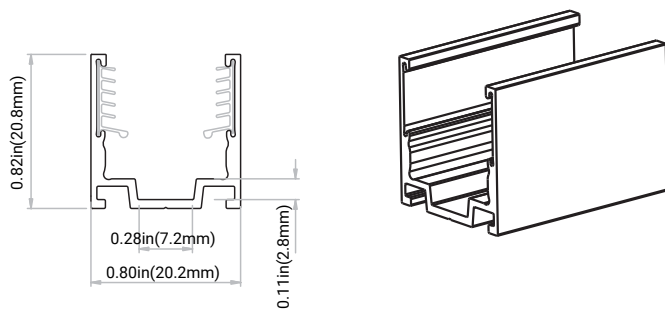

Tolerance:  $\pm 0.008(\pm 0.2\text{mm})$

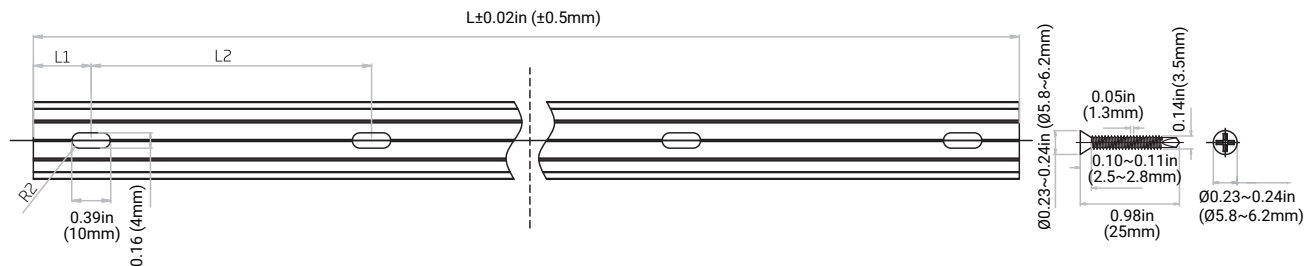

**Note:**

1. L1 refers to mounting holes.
2. L2 refers to mounting holes centers.

| Item Code | Standard Length | L1           | L2           | Slotted Hole Dimensions | Number of Holes |
|-----------|-----------------|--------------|--------------|-------------------------|-----------------|
| 053009    | 0.79in/20mm     | 0.39in/10mm  | /            | 0.16x0.39in/4x10mm      | 1               |
| 053008    | 39.37in/1000mm  | 3.93in/100mm | 7.87in/200mm | 0.16x 0.39in/4x10mm     | 5               |

Specifications sheets are subject to change without notification.

# Flange Internal Serrated Aluminum Profile



Flange Aluminum mounting profile for recessed applications is constructed with 6063 Aluminum. The Flange Aluminum Profile easily fits inside a mounting groove for easy installation. Using the integral serrated tape the Flange Internal Serrated Aluminum profile is simple, secure and easy to maintain. The profile is designed to last in extreme environments and tested for weather resistance in accordance to IEC 68-2-11.

Please refer to the application installation Instructions.

## Dimension: inches

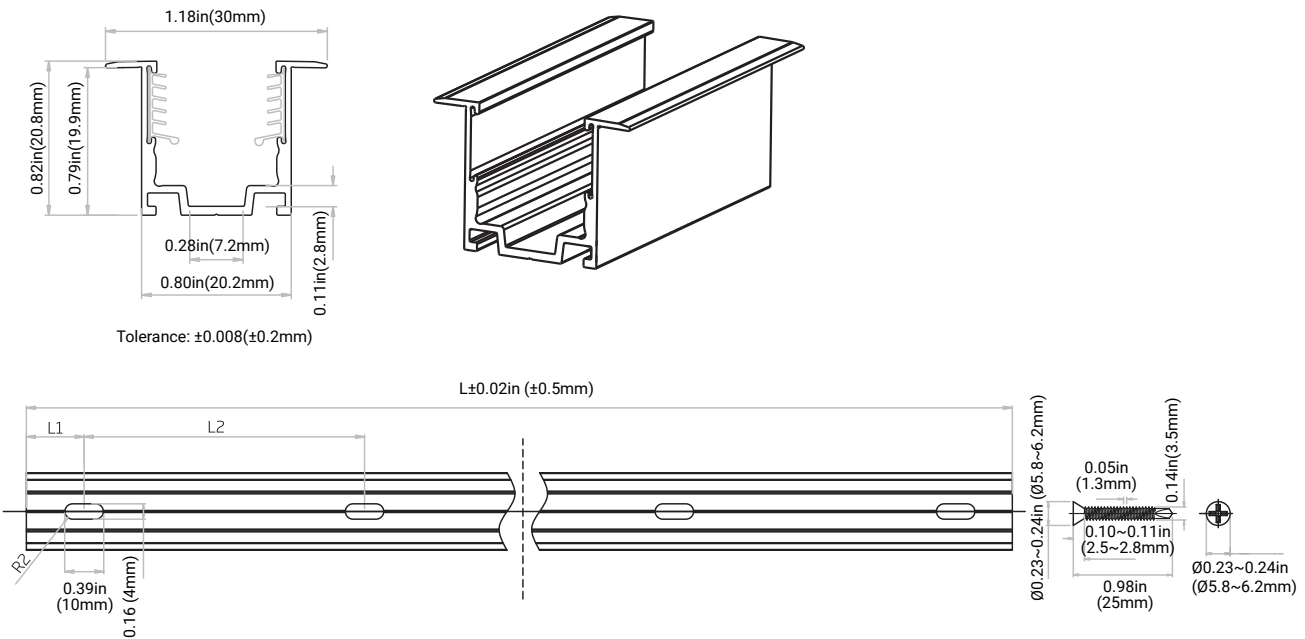

**Note:**

1. L1 refers to mounting holes.
2. L2 refers to mounting holes centers.

| Item Code | Standard Length | L1           | L2           | Slotted Hole Dimensions | Number of Holes |
|-----------|-----------------|--------------|--------------|-------------------------|-----------------|
| 053011    | 0.79in/20mm     | 0.39in/10mm  | /            | 0.16x0.39in/4x10mm      | 1               |
| 053010    | 39.37in/1000mm  | 3.93in/100mm | 7.87in/200mm | 0.16x0.39in/4x10mm      | 5               |

Specifications sheets are subject to change without notification.

# Bendable Serrated Aluminum Profile

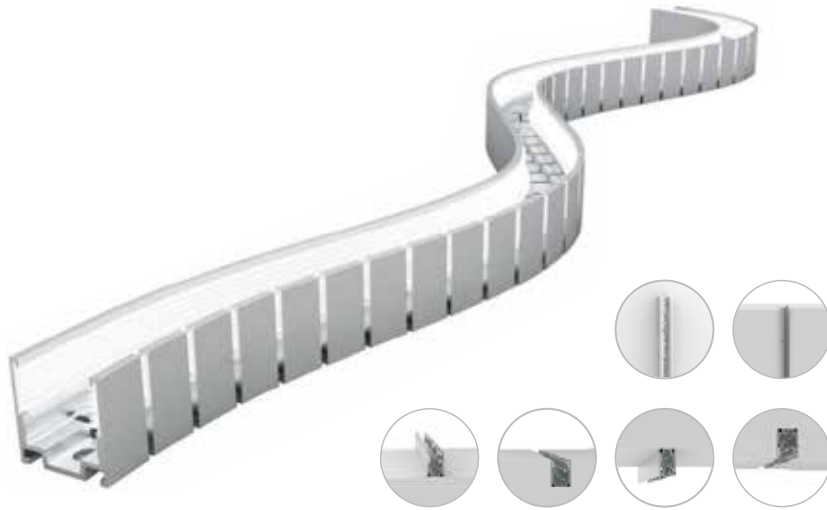

Bendable Serrated Aluminum Profile is designed to securely fasten the LEDs regardless of the mounting orientation and hold any horizontally curved design. The profile is designed to last in extreme environments and tested for weather resistance in accordance to IEC 68-2-11.

Please refer to the application installation Instructions.

## Dimension: inches

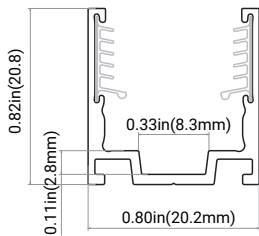

Tolerance:  $\pm 0.008(\pm 0.2\text{mm})$

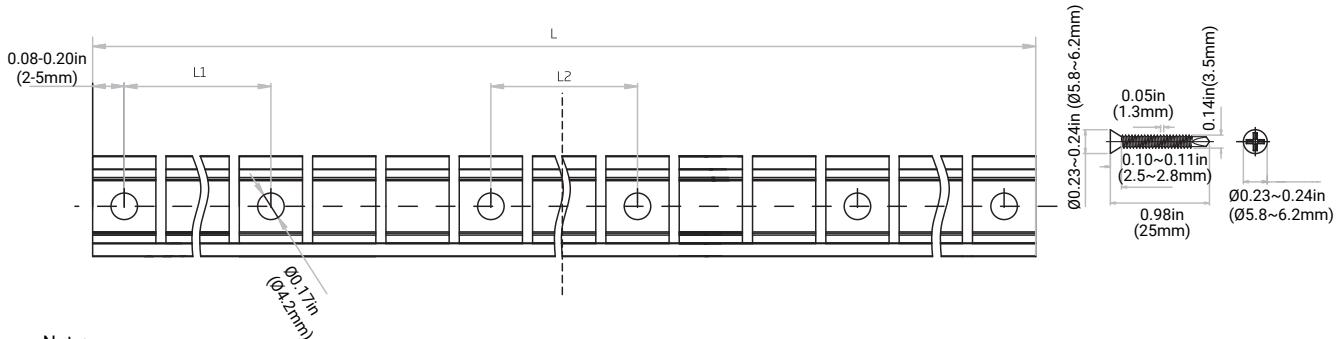
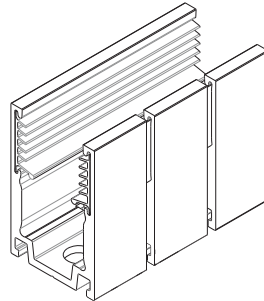

**Note:**

1. L1 refers to mounting holes.
2. L2 refers to mounting holes centers.

| Item Code | Standard Length | L1             | L2            | Slotted Hole Dimensions | Number of Holes |
|-----------|-----------------|----------------|---------------|-------------------------|-----------------|
| 053013    | 19.68in/500mm   | 4.59in/116.5mm | 0.92in/23.3mm | 0.17in/Ø4.2mm           | 6               |
| 053012    | 39.37in/1000mm  | 4.59in/116.5mm | 2.29in/58.2mm | 0.17in/Ø4.2mm           | 10              |

Specifications sheets are subject to change without notification.

# Installation Instructions

Please read instructions carefully before operation.

## Bending Diameter

Min. Bending Diameter (Toothed Side inwards)

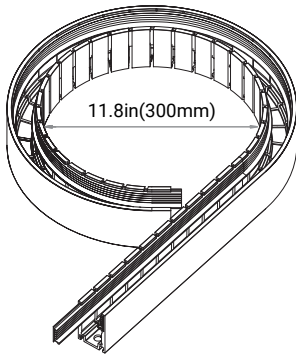

Min. Bending Diameter (Toothed Side outwards)

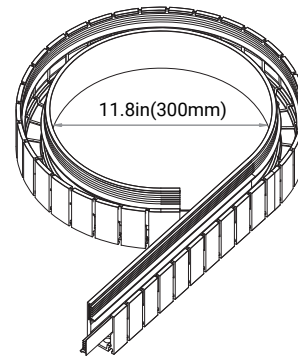

## Installation

### STEP 1

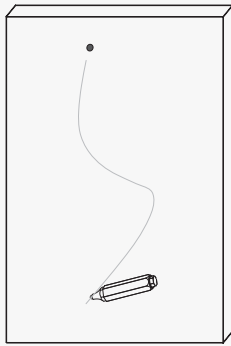

Mark the required shape on the mounting.

### STEP 2

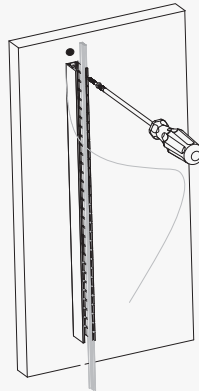

Get the front connector outside of profile and keep at least 0.39in (10mm) apart. Fix the screw starting from the power input end.

### STEP 3

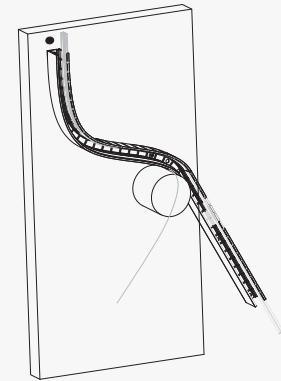

Use cylinder or disc-like object you have to assist with shaping.

### STEP 4

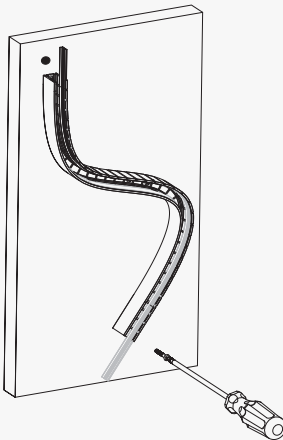

Fix the rest in sequence along with the marks.

### STEP 5

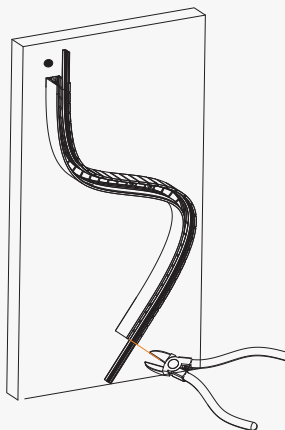

Adjust the serrated silicone tape and remove the redundant lengths at both ends.

### STEP 6

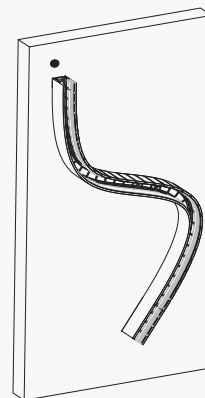

Finish and fix the light in.

Specifications sheets are subject to change without notification.

# Operating Instructions for Profiles



Aluminum Profile



Flange Aluminum Profile



Internal Serrated Aluminum Profile



Flange Internal Serrated Aluminum Profile



Hybrid Profile



Thickened Plastic Profile



Bendable Serrated Aluminum Profile

## Profile Cutting



Make sure the cross-section of profile is smooth without any burrs when you cut the profile.

For the profiles with serrated tape, if dropped after cutting, insert and fix it to the profile by applying adhesive glue on its backside, 0.2~0.3in(5~8in) diameter of touching area is enough. Make sure its round head on the edge is downward when adhering.



## Profile Installation

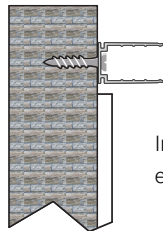
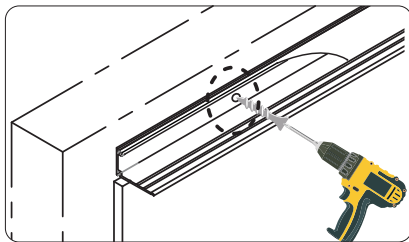

Install the screw into position and ensure the screw head is flush.

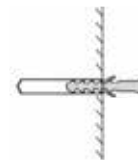

Place rubber expansion bolt to fix the screw if needed.



Ensure that the profile free of debris before installation.



No protruding screws in the slot. This will damage the light.



Do not use a deformed profile.

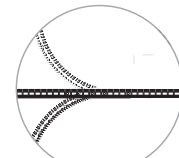

Avoid repeat shaping as this may cause damage.

When there is debris in the profile or the screw is protruding, the housing is subject to damage.

## Profile Jointing



Aligned housing joints. The gap between two mounting profiles should not be more than 0.2in(5mm).



The profiles can be installed at a right angle if there are two LEDs connected at a right angle.



In the case that one LED strip is installed around a corner, ensure the profiles leave enough space to adapt to minimum bending diameter.



Angular Misalignment



Parallel Horizontal Misalignment



Parallel Vertical Misalignment

Misaligned joints will damage PCB and the housing.

## Light Installation



Align the LED to the housing profile.



Gently push-fit the LED into the profile.



While push-fitting, Do not vertically bend the LED strip at an angle more than 15°. This will damage the LED.



When the length of LED >6ft(2m), 2 or more people are required for handling.

## Light Uninstallation



Step 1: Insert a screwdriver at the bottom of the LED strip.



Step 2: Using the screwdriver, remove the LED upwardly. While removing, Do not vertically bend the LED strip at an angle more than 15°. This will damage the LED.



Step 3: Once the end of light is out, hold both sides of light and pull it out along the profile slowly.



When the length of LED >6ft(2m), 2 or more people are required for handling.