

Aqueon® Diffuse RGB/RGBW-Pixel

Standard & High Power 24V DC

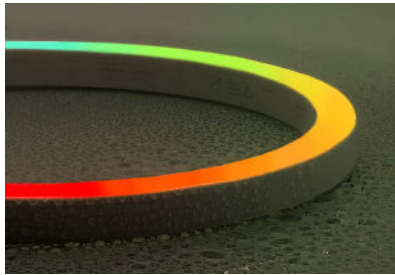

Aqueon Diffuse Pixel is a product that each segment is individually addressable so that you can achieve myriad color changing or animation effects via SPI controller. Available in both vertical and horizontal bending. IP67 or IP68 submersible UV and chemical resistant encapsulation. SPI protocol product with built-in IC chip of USC2903 or UCS2904.

Project

Date

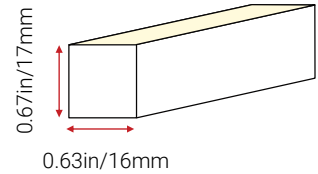

FEATURES

- IK10, cUL Listed, UL Listed 676, UL Listed 2108, CE - Submersible / IP68
- Horizontal or Vertical bending options
- End to end continuous illumination / 25.6 LEDs per ft (84 LEDs per meter)
- Up to 49.2ft(15m) continuous runs; Flood and vibration proof
- **Standard:** Cuttable / Addressable Section every 6.56"(166.7mm)
14 LEDs per pixel / 1.83 pixels per ft (6 pixels per meter)
- **High Power:** Cuttable / Addressable Section every 3.28"(83.3mm)
7 LEDs per pixel / 3.66 pixels per ft (12 pixels per meter)
- Pixel RGB & RGBW options
- Ultra low energy; RGB - 2.74W/ft | RGBW - 3.66W/ft (12W/m)
- 6"(150mm) minimum bending radius
- 5 year limited warranty; 60,000 hrs LED lifetime
- Dimmable with SPI & DMX
- UV/IR protected Silicone material
- Ambient working temperature -40°F~113°F(-40°C~45°C)

ANTI-WICKING

All connections include a ferrule on the power feed to prevent water wicking through the connection point.



PART NUMBER & SPECIFICATIONS

Part #	Color	CRI	lm/ft	lm/m	Max Run	W/ft	W/m
Standard Aqueon® Diffuse RGB/RGBW Pixel - Horizontal Bend							
052248	RGB	>80	58	188	49.2ft	15m	2.74 9
052247	RGBW-27K	>80	63	205	49.2ft	15m	3.66 12
052244	RGBW-30K	>80	63	205	49.2ft	15m	3.66 12
052246	RGBW-40K	>80	63	205	49.2ft	15m	3.66 12
High Power Aqueon® Diffuse RGB/RGBW Pixel - Horizontal Bend							
052248-16.5	RGB	>80	105	345	32.8ft	10m	5.03 16.5
052247-22	RGBW-27K	>80	114	375	26.2ft	8m	6.7 22
052244-22	RGBW-30K	>80	114	375	26.2ft	8m	6.7 22
052246-22	RGBW-40K	>80	114	375	26.2ft	8m	6.7 22
Standard Aqueon® Diffuse RGB/RGBW Pixel - Vertical Bend							
052243	RGB	>80	62	202	49.2ft	15m	2.74 9
052242	RGBW-27K	>80	75	245	49.2ft	15m	3.66 12
052240	RGBW-30K	>80	75	245	49.2ft	15m	3.66 12
052241	RGBW-40K	>80	75	245	49.2ft	15m	3.66 12
High Power Aqueon® Diffuse RGB/RGBW Pixel - Vertical Bend							
052243-16.5	RGB	>95	113	370	32.8ft	10m	5.03 16.5
052242-22	RGBW-27K	>95	137	450	26.2ft	8m	6.7 22
052240-22	RGBW-30K	>95	137	450	26.2ft	8m	6.7 22
052241-22	RGBW-40K	>95	137	450	26.2ft	8m	6.7 22

HORIZONTAL BENDING

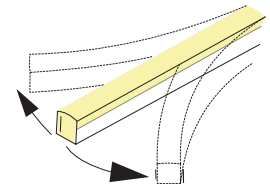

VERTICAL BENDING

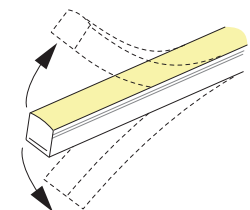

Specifications may be modified or improved without notification



CONNECTORS & ACCESSORIES

Factory assembled 3-wired RGBW Aqueon IP68 submersible accessories include end caps, extension cords and connectors with customizable cord lengths. IP67 self assembly connectors are also available.

Project

Date

FACTORY ASSEMBLED IP68 CONNECTORS

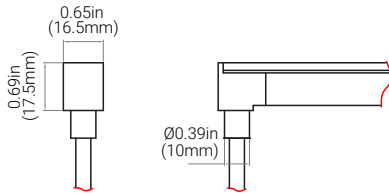

Bottom Feed Connector, 16'L
#052255-CU16

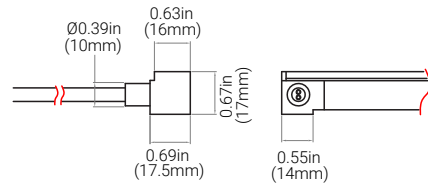

Side Feed Connector, 16'L
#052257-CU16

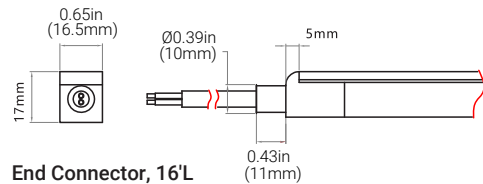

End Connector, 16'L
#052256-CU16

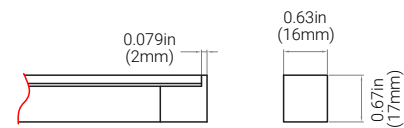

End Cap
#052286

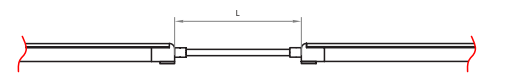

Extension
#052270 L available in 0.3m-1m

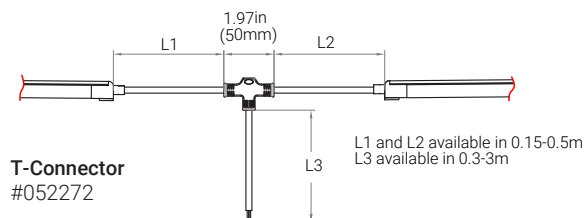

T-Connector
#052272

L1 and L2 available in 0.15-0.5m
L3 available in 0.3-3m

FIELD ASSEMBLY SNAP IP67 CONNECTORS

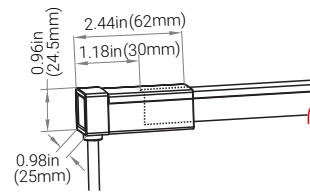

Bottom Snap Connector, 16'L
#052255S-CU16

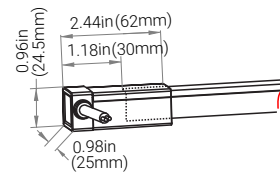

Side Feed Snap Connector, 16'L
#052257S-CU16

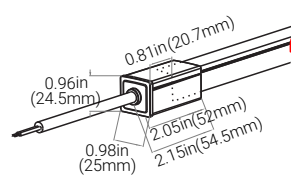

End Snap Connector, 16'L
#052256S-CU16

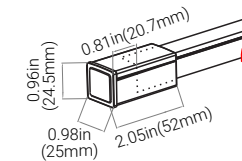

Snap End Cap
#052286S

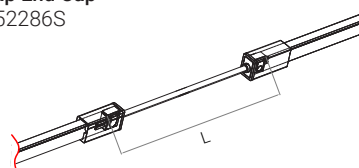

Snap Extension
#052270S L available in 0.3m, 1m, 3m

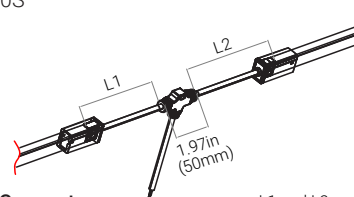

Snap T-Connector
#052272S

L1 and L2 available in 0.3m

Specifications may be modified or improved without notification

Aqueon® Diffuse RGB/RGBW-Pixel Standard & High Power



POWER SUPPLIES - 24V

Forward Phase, Reverse Phase, & 0-10V Dimming Drivers. Remote enclosures available.

Part #	Ingress	Voltage	Wattage	Dimensions (inches / mm)	Description
045001	IP67	100-305V	20W	7.6 x 1.18 x 0.79 / 193 x 30 x 20	Dimmable LED Driver
045002	IP67	100-305V	40W	5.83 x 1.57 x 0.87/148 x 40 x 22	Dimmable LED Driver
045003	IP67	120-277V	60W	6.3 x 2.24 x 1.5/160 x 57 x 38	Dimmable LED Driver
045004	IP67	120-277V	75W	6.3 x 2.24 x 1.5/160 x 57 x 38	Dimmable LED Driver
045005	IP67	120-277V	96W	7.6 x 2.24 x 1.5/193 x 57 x 38	Dimmable LED Driver
045006	IP67	120-277V	200W	10.1 x 3.03 x 1.8/257 x 77 x 46	Dimmable LED Driver
045007	IP67	120-277V	300W	11.9 x 3.03 x 1.8/302 x 77 x 46	Dimmable LED Driver

ENCLOSURES

Part #	Ingress	Dimensions (inches / mm)	Description
045008	IP67	11.02 x 4.05 x 2.2 / 280 x 103 x 56	20W Enclosure
045009	IP67	11.02 x 4.05 x 2.2 / 280 x 103 x 56	40W Enclosure
045010	IP67	11.02 x 4.05 x 2.2 / 280 x 103 x 56	60W Enclosure
045011	IP67	11.02 x 4.05x 2.2 / 280 x 103 x 56	75W Enclosure
045012	IP67	11.02 x 4.05 x 2.2 / 280 x 103 x 56	96W Enclosure
045013	IP67	16.7 x 9.8 x 2.3 / 424 x 249 x 58	200W Enclosure
045014	IP67	16.7 x 9.8 x 2.3 / 424 x 249 x 58	300W Enclosure
PC-JBOX	IP67	4.25 x 1.63 x 1.25 / 108 x 41 x 32	Waterproof J-Box

DMX CONTROLLER

Part #	Description
011410	Nicolaude DE3 DMX 512 Controller
011403	Nicolaude DINA-DR1 DMX 512 Controller
050203	LT-200 SPI Controller - For Pixel
050205	DMX512 SPI Converter Decoder - For Pixel

Project

Date

20W-60W Dimmable Driver



75W-300W Dimmable Driver



Nicolaude DE3 DMX 512 Controller



MOUNTINGS & EXTRUSIONS

Mounting Channels to Match any Installation

Aluminum Profile



- High Quality Aluminum
- Lightweight
- Cost Effective
- Warp/corrosion resistant

1.38in(35mm) L - #053001
39.37in(1000mm) L - #053000

Flanged Aluminum Profile



- High Quality Aluminum
- Lightweight
- Cost Effective
- Flange for Recessed Installation

1.38in(35mm) L - #053003
39.37in(1000mm) L - #053002

Flanged Internal Serrated Aluminum Profile



- Lightweight
- Easy to Install & Dismantle
- Continuous & Strong Gripping
- Flange for Recessed Installation

0.79in(20mm) L - #053011
39.37in(1000mm) L - #053010

Internal Serrated Aluminum Profile



- Continuous & Strong Gripping
- Lightweight
- Easy to Install & Dismantle
- For Suspended Installations

0.79in(20mm) L - #053009
39.37in(1000mm) L - #053008

Bendable Serrated Aluminum Profile



- High Quality Aluminum
- Easy to Install & Dismantle
- Continuous & Strong Gripping
- Memory Retaining
- Perfect for Curved Installations

19.68in(500mm) L - #053013
39.37in(1000mm) L - #053012

Thickened Plastic Profile



- Plastic Profile 0.12in(3mm) thick
- Lightweight
- Cost Effective
- Rust & Corrosion Resistant

1.38in(35mm) L - #053005
39.37in(1000mm) L - #053004

Specifications may be modified or improved without notification



MOUNTINGS & EXTRUSIONS (CONTINUED)

Raceway Aluminum Profile



- Surface-mounted
- Serrated Aluminum Profile

39.37in(1000mm) L
#053021

Suspended Raceway Aluminum Profile



- Suspended
- Serrated Aluminum Profile

39.37in(1000mm) L
#053022

Raceway End Cap



#053023

Raceway Splice Connector



#053024

Stainless Steel Clip



- High Quality Stainless Steel
- Cost Effective

1.38in(35mm) L
#053020

Silicone 3D Bend Profile White



- Silicone
- Bendable Anole Profile

39.37in(1000mm) L
#053026-WH

Silicone 3D Bend Profile Black



- Silicone
- Bendable Anole Profile

39.37in(1000mm) L
#053026-BL

ELECTRICAL DETAILS

Pixel / Single-end Feed

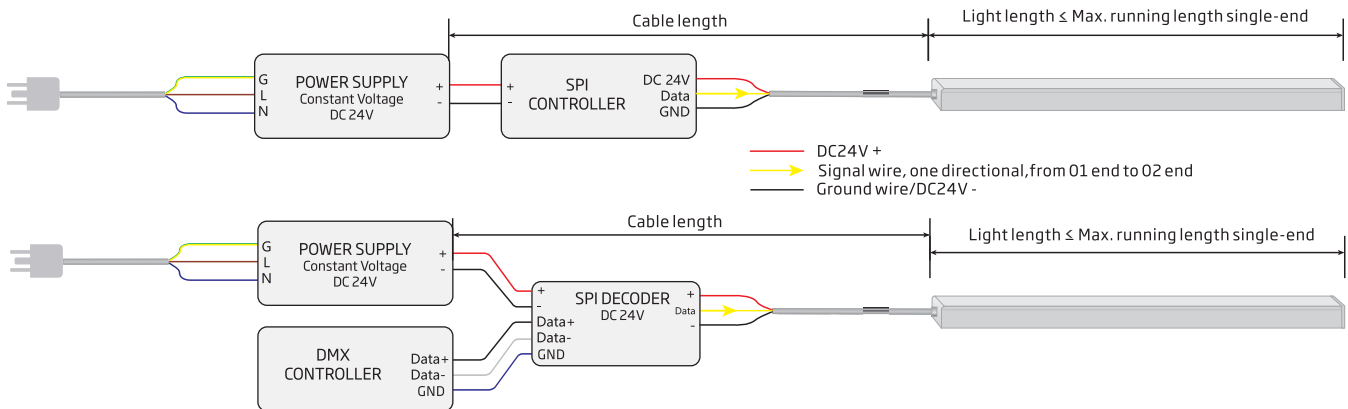

CABLE REQUIREMENT

The Aqueon® LED strips need a minimum voltage at the beginning of the LED strip to function according to the specifications. The table below gives an indication of the maximum cable length based on the cable thickness. The standard starter cable is (18 AWG), see table below for max cable lengths.

In case the required length is longer than the length mentioned in this cable, it is recommended to cut the starter cable down to 1ft (0.3m) and splice a larger gauge cable. Please contact your distributor for a detailed cable calculation.

Cable X Information	LED Strip	Max. Cable Length
9W&12W		24V
18 AWG *Standard	3.28ft / 1m	362.8ft / 110.6m
	16.4ft / 5m	66.5ft / 20.3m
	32.8ft / 10m	27.2ft / 8.3m
	39.4ft / 12m	17.7ft / 5.4m
	49.2ft / 15m	2ft / 6.6m
16 AWG	3.28ft / 1m	591.1ft / 180.2m
	16.4ft / 5m	108.4ft / 33m
	32.8ft / 10m	44.3ft / 13.5m
	39.4ft / 12m	28.8ft / 8.8m
	49.2ft / 15m	14.8ft / 4.5m
14 AWG	3.28ft / 1m	927ft / 282.6m
	16.4ft / 5m	170ft / 51.8m
	32.8ft / 10m	69.5ft / 21.2m
	39.4ft / 12m	45.1ft / 13.8m
	49.2ft / 15m	23.2ft / 7.1m

Cable X Information	LED Strip	Max. Cable Length
16.5W		24V
18 AWG *Standard	3.28ft / 1m	278.1ft / 84.8m
	9.84ft / 3m	89.3ft / 27.2m
	16.4ft / 5m	48.8ft / 14.9m
	23ft / 7m	29.9ft / 9.1m
	32.8ft / 10m	27.9ft / 8.5m
16 AWG	3.28ft / 1m	453.2ft / 138.1m
	9.84ft / 3m	145.6ft / 44.4m
	16.4ft / 5m	79.6ft / 24.3m
	23ft / 7m	48.8ft / 14.9m
	32.8ft / 10m	45.5ft / 13.9m
14 AWG	3.28ft / 1m	710.7ft / 216.6m
	9.84ft / 3m	228.3ft / 69.6m
	16.4ft / 5m	124.8ft / 38m
	23ft / 7m	76.5ft / 23.3m
	32.8ft / 10m	71.3ft / 21.7m

Cable X Information	LED Strip	Max. Cable Length
22W		24V
18 AWG *Standard	3.28ft / 1m	187.5ft / 57.1m
	9.84ft / 3m	59.2ft / 18.1m
	16.4ft / 5m	31ft / 9.5m
	26.25ft / 8m	14.5ft / 4.4m
16 AWG	3.28ft / 1m	305.5ft / 93.1m
	9.84ft / 3m	96.5ft / 29.4m
	16.4ft / 5m	50.6ft / 15.4m
	26.25ft / 8m	23.6ft / 7.2m
14 AWG	3.28ft / 1m	479.1ft / 146m
	9.84ft / 3m	151.4ft / 46.1m
	16.4ft / 5m	79.3ft / 24.2m
	26.25ft / 8m	37.1ft / 11.3m

NOTE: To avoid signal degradation, please ensure the data cable length is within the maximum signal transmission distance according to the specification of controller/decoder.

