

# Aqueon® 3D Diffuse Tunable White

Standard & High Power 24V DC 22 - 57



Aqueon 3D delivers up to 49 feet of low-glare, tri-surface illumination with precise diffusion & uniform light intensity across all three planes. Precise tunable white allows for changing color of the light from warm, neutral, to cool mimicking natural daylight changes for a more personalized lighting experience. Aqueon sets a new standard of flexible light; superior standards new materials, new methods, military grade components and advanced circuit design to create a flood proof; vibration proof seamless line of light. IP68 and UL submersible with Single bin premium Nichia LEDs for a lifetime of accurate color rendering, minimal color shift and exceptional color consistency.

## FEATURES

- IK07, UL Listed 676, cUL Listed, UL Listed 2108 - Submersible / IP68
- 272° diffused illumination with no visible LEDs
- End to end continuous illumination
- Up to 49.2ft(15m) continuous runs; Flood and vibration proof
- Cuttable every 3.28"(83.3mm)
- White Tuning Range from 2200K to 5700K
- Ultra low energy; 2.74W/ft (9W/m)
- 6" (150mm) minimum bending radius
- 5 year limited warranty; 50,000 hr LED lifetime
- Dimmable with Pulse Width Modulation & DMX
- UV/IR protected Silicone material
- Ambient working temperature -40°F - 131°F (-40°C ~ 55°C)

## PART NUMBER & SPECIFICATIONS

Part #	Color	CRI	lm/ft	lm/m	Max Run	W/ft	W/m
<b>Aqueon® 3D Diffuse TW</b>							
053050	2200-5700K	>80	172	562	49.2ft 15m	2.74	9
<b>High Power Aqueon® 3D Diffuse TW</b>							
053050-12	2200-5700K	>80	229	750	49.2ft 15m	3.66	12

Specifications may be modified or improved without notification

Organic Lighting | 12203 Magnolia Avenue, Suite 1, Riverside CA 92503 | 626.969.6140 | www.organiclighting.com | 12/2024 V8

ORGANIC LIGHTING®

Project

Date

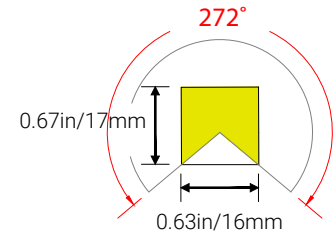

## VERTICAL BENDING

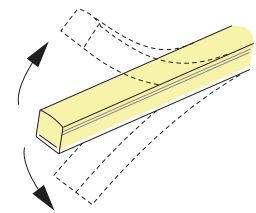

## ANTI-WICKING

All connections include a ferrule on the power feed to prevent water wicking through the connection point.

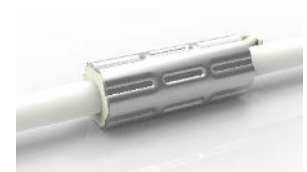

## CONNECTORS & ACCESSORIES

Factory assembled 3-wired Aqueon IP68 submersible accessories include end caps, extension cords and connectors with customizable cord lengths. IP67 self assembly connectors are also available.

Project

Date

### FACTORY ASSEMBLED IP68 CONNECTORS

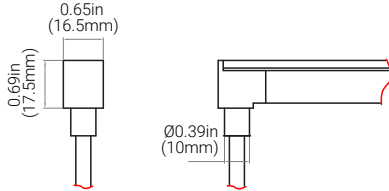

**Bottom Feed Connector, 16'L**  
#052255-CU16

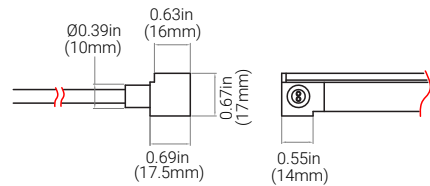

**Side Feed Connector, 16'L**  
#052257-CU16

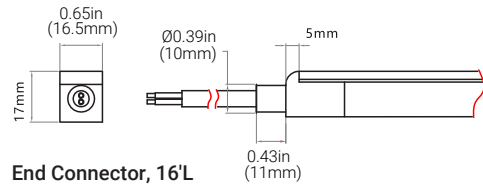

**End Connector, 16'L**  
#052256-CU16

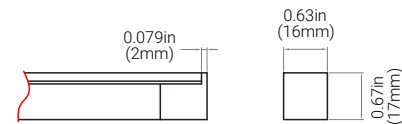

**End Cap**  
#052286

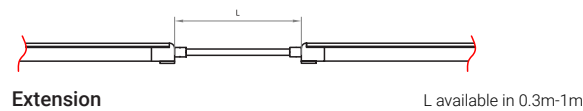

**Extension**  
#052270

L available in 0.3m-1m

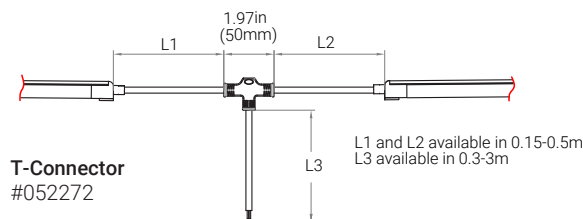

**T-Connector**  
#052272

L1 and L2 available in 0.15-0.5m  
L3 available in 0.3-3m

### FIELD ASSEMBLY SNAP IP67 CONNECTORS

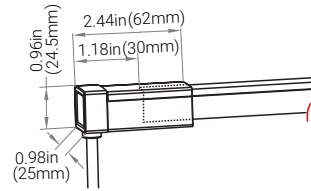

**Bottom Snap Connector, 16'L**  
#052255S-CU16

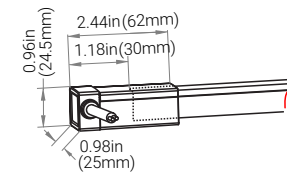

**Side Feed Snap Connector, 16'L**  
#052257S-CU16

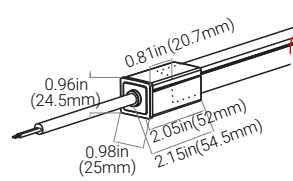

**End Snap Connector, 16'L**  
#052256S-CU16

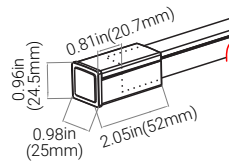

**Snap End Cap**  
#052286S

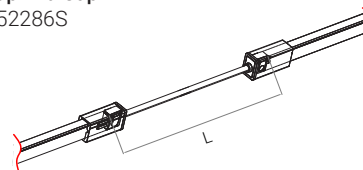

**Snap Extension**  
#052270S

L available in 0.3m, 1m, 3m

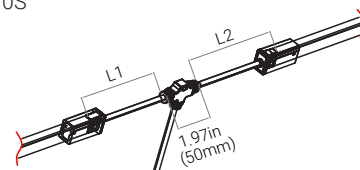

**Snap T-Connector**  
#052272S

L1 and L2 available in 0.3m

Specifications may be modified or improved without notification

# Aqueon® 3D Diffuse Tunable White Standard & High Power



## POWER SUPPLIES - 24V

Forward Phase, Reverse Phase, & 0-10V Dimming Drivers. Remote enclosures available.

Part #	Ingress	Voltage	Wattage	Dimensions (inches / mm)	Description
045001	IP67	100-305V	20W	7.6 x 1.18 x 0.79 / 193 x 30 x 20	Dimmable LED Driver
045002	IP67	100-305V	40W	5.83 x 1.57 x 0.87 / 148 x 40 x 22	Dimmable LED Driver
045003	IP67	120-277V	60W	6.3 x 2.24 x 1.5 / 160 x 57 x 38	Dimmable LED Driver
045004	IP67	120-277V	75W	6.3 x 2.24 x 1.5 / 160 x 57 x 38	Dimmable LED Driver
045005	IP67	120-277V	96W	7.6 x 2.24 x 1.5 / 193 x 57 x 38	Dimmable LED Driver
045006	IP67	120-277V	200W	10.1 x 3.03 x 1.8 / 257 x 77 x 46	Dimmable LED Driver
045007	IP67	120-277V	300W	11.9 x 3.03 x 1.8 / 302 x 77 x 46	Dimmable LED Driver

## ENCLOSURES

Part #	Ingress	Dimensions (inches / mm)	Description
045008	IP67	9.4 x 2.6 x 1.9 / 239 x 66 x 48	20W Enclosure
045009	IP67	11.02 x 4.05 x 2.2 / 280 x 103 x 56	40W Enclosure
045010	IP67	11.02 x 4.05 x 2.2 / 280 x 103 x 56	60W Enclosure
045011	IP67	11.02 x 4.05 x 2.2 / 280 x 103 x 56	75W Enclosure
045012	IP67	11.02 x 4.05 x 2.2 / 280 x 103 x 56	96W Enclosure
045013	IP67	16.7 x 9.8 x 2.3 / 424 x 249 x 58	200W Enclosure
045014	IP67	16.7 x 9.8 x 2.3 / 424 x 249 x 58	300W Enclosure
PC-JBOX	IP67	4.25 x 1.63 x 1.25 / 108 x 41 x 32	Waterproof J-Box

## DMX CONTROLLER

Part #	Description
011343	100W Digital Controller
011344	180W Digital Controller
011345	720W Digital Controller
011341	Digital Controller & Power Supply Combination
011410	Nicolaude DE3 DMX 512 Controller
011403	Nicolaude DINA-DR1 DMX 512 Controller

## MOUNTINGS & EXTRUSIONS

Mounting Channels to Match any Installation

### Aluminum Channel



- High Quality Aluminum
  - Lightweight
  - Cost Effective
- 3.25ft (1m) L - #051694

### Thickened Plastic Profile



- Plastic Profile 0.12in(3mm) thick
- Lightweight
- Cost Effective
- Rust & Corrosion Resistant

1.38in (35mm) L - #053005  
39.37in (1000mm) L - #053004

Project

Date

### 20W -60W Dimmable Driver



### 75W -300W Dimmable Driver



### Digital Controller (100W, 180W, 720W)



### Nicolaude DE3 DMX 512 Controller



Specifications may be modified or improved without notification



## CABLE REQUIREMENT

The Aqueon® LED strips need a minimum voltage at the beginning of the LED strip to function according to the specifications. The table below gives an indication of the maximum cable length based on the cable thickness. The standard starter cable is (18 AWG), see table below for max cable lengths.

In case the required length is longer than the length mentioned in this cable, it is recommended to cut the starter cable down to 1ft (0.3m) and splice a larger gauge cable. Please contact your distributor for a detailed cable calculation.

Cable X Information	LED Strip	Max. Cable Length
		24V
*18 AWG *standard	3.28 ft / 1m	159ft / 48m
	16.4 ft / 5m	32ft / 10m
	32.8 ft / 10m	18ft / 5.5m
	49.2 ft / 15m	11.5ft / 3.5m
16 AWG	3.28 ft / 1m	260ft / 79m
	16.4 ft / 5m	52ft / 16m
	32.8 ft / 10m	29.5ft / 9m
	49.2 ft / 15m	20ft / 6m
14 AWG	3.28 ft / 1m	416ft / 127m
	16.4 ft / 5m	82ft / 25m
	32.8 ft / 10m	47.5ft / 14.5m
	49.2 ft / 15m	101.7ft / 31m

## ELECTRICAL DETAILS

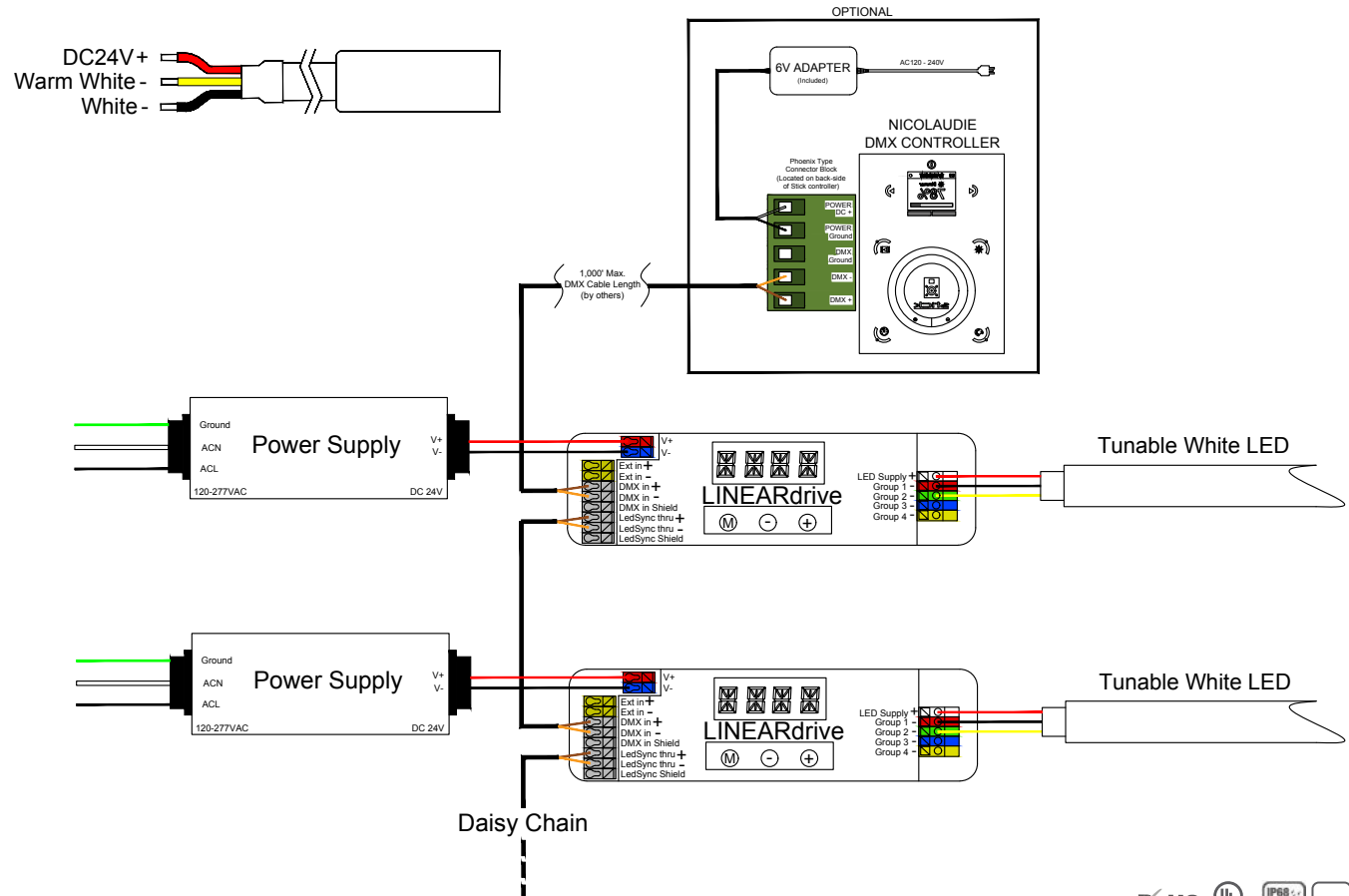

Specifications may be modified or improved without notification