

Aqueon® 3D Diffuse RGB

Standard & High Power 24V DC 

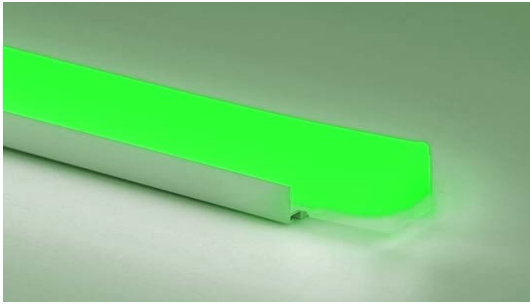

Aqueon 3D delivers up to 49 feet of low-glare, tri-surface illumination with precise diffusion & uniform color saturation across all three planes. DMX or PWM RGB color changing allows for creating a unlimited number of theatrical themes for a completely customized lighting experience. Aqueon sets a new standard of flexible light; superior standards new materials, new methods, military grade components and advanced circuit design to create a flood proof; vibration proof seamless line of light. IP68 and UL submersible with Single bin premium Nichia LEDs for a lifetime of accurate color rendering, minimal color shift and exceptional color consistency.

FEATURES

- IK07, UL Listed 676, cUL Listed, UL Listed 2108 - Submersible / IP68
- 272° diffused illumination with no visible LEDs
- End to end continuous illumination
- Up to 49.2ft(15m) continuous runs; Flood and vibration proof
- Cuttable every 3.28"(83.3mm)
- Static RGB
- Ultra low energy; 2.74W/ft (9W/m)
- 6"(150mm) minimum bending radius
- 5 year limited warranty; 60,000 hrs LED lifetime
- Dimmable with Pulse Width Modulation & DMX
- UV/IR protected Silicone encapsulation
- Ambient working temperature -40°F - 131°F (-40°C ~ 55°C)

PART NUMBER & SPECIFICATIONS

Part #	Color	CRI	lm/ft	lm/m	Max Run	W/ft	W/m
Standard Aqueon® 3D Diffuse RGB							
053045	RGB	>80	45.7	150	49.2ft 15m	1.83	6
High Power Aqueon® 3D Diffuse RGB							
053045-12	RGB	>80	166	545	32.8ft 10m	3.66	12

ORGANIC LIGHTING®

Project

Date

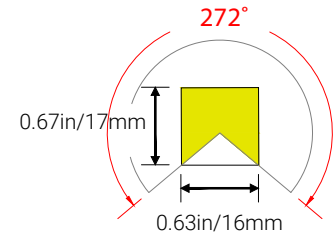

VERTICAL BENDING

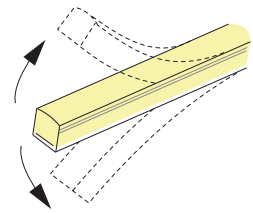

ANTI-WICKING

All connections include a ferrule on the power feed to prevent water wicking through the connection point.

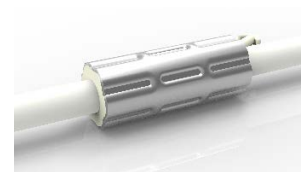

Specifications may be modified or improved without notification

Organic Lighting | 12203 Magnolia Avenue, Suite 1, Riverside CA 92503 | 626.969.6140 | www.organiclighting.com | 01/2025 V5



Aqueon® 3D Diffuse RGB Standard & High Power

CONNECTORS & ACCESSORIES

Factory assembled 4-wired RGB Aqueon IP68 submersible accessories include end caps, extension cords and connectors with customizable cord lengths. IP67 self assembly connectors are also available.

Project
Date

FACTORY ASSEMBLED IP68 CONNECTORS

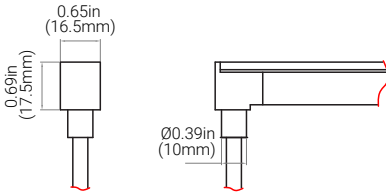

Bottom Feed Connector, 16'L
RGB #052253-CU16

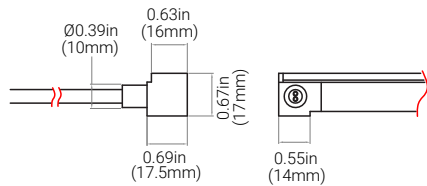

Side Feed Connector, 16'L
RGB #052254-CU16

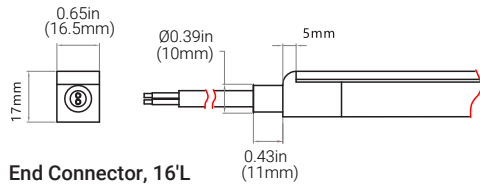

End Connector, 16'L
RGB #052252-CU16

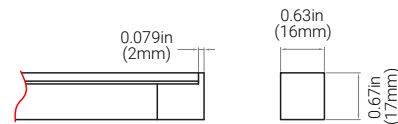

End Cap
#052286

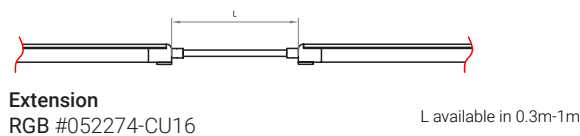

Extension
RGB #052274-CU16

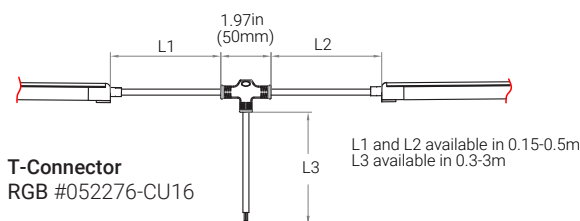

T-Connector
RGB #052276-CU16

FIELD ASSEMBLY SNAP IP67 CONNECTORS

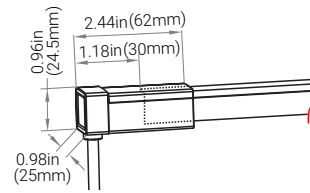

Bottom Snap Connector, 16'L
RGB #052253S-CU16

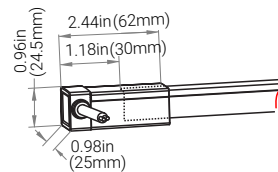

Side Feed Snap Connector, 16'L
RGB #052254S-CU16

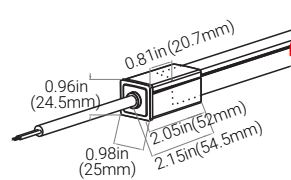

End Snap Connector, 16'L
RGB #052252S-CU16

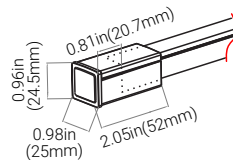

Snap End Cap
#052236S

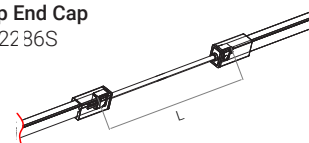

Snap Extension
RGB #052274S-CU16

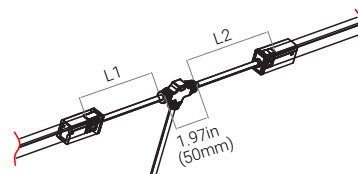

Snap T-Connector
RGB #052276S-CU16

Specifications may be modified or improved without notification

Aqueon® 3D Diffuse RGB Standard & High Power



POWER SUPPLIES - 24V

Forward Phase, Reverse Phase, & 0-10V Dimming Drivers. Remote enclosures available.

Part #	Ingress	Voltage	Wattage	Dimensions (inches / mm)	Description
045001	IP67	100-305V	20W	7.6 x 1.18 x 0.79 / 193 x 30 x 20	Dimmable LED Driver
045002	IP67	100-305V	40W	5.83 x 1.57 x 0.87 / 148 x 40 x 22	Dimmable LED Driver
045003	IP67	120-277V	60W	6.3 x 2.24 x 1.5 / 160 x 57 x 38	Dimmable LED Driver
045004	IP67	120-277V	75W	6.3 x 2.24 x 1.5 / 160 x 57 x 38	Dimmable LED Driver
045005	IP67	120-277V	96W	7.6 x 2.24 x 1.5 / 193 x 57 x 38	Dimmable LED Driver
045006	IP67	120-277V	200W	10.1 x 3.03 x 1.8 / 257 x 77 x 46	Dimmable LED Driver
045007	IP67	120-277V	300W	11.9 x 3.03 x 1.8 / 302 x 77 x 46	Dimmable LED Driver

ENCLOSURES

Part #	Ingress	Dimensions (inches / mm)	Description
045008	IP67	9.4 x 2.6 x 1.9 / 239 x 66 x 48	20W Enclosure
045009	IP67	11.02 x 4.05 x 2.2 / 280 x 103 x 56	40W Enclosure
045010	IP67	11.02 x 4.05 x 2.2 / 280 x 103 x 56	60W Enclosure
045011	IP67	11.02 x 4.05 x 2.2 / 280 x 103 x 56	75W Enclosure
045012	IP67	11.02 x 4.05 x 2.2 / 280 x 103 x 56	96W Enclosure
045013	IP67	16.7 x 9.8 x 2.3 / 424 x 249 x 58	200W Enclosure
045014	IP67	16.7 x 9.8 x 2.3 / 424 x 249 x 58	300W Enclosure
PC-JBOX	IP67	4.25 x 1.63 x 1.25 / 108 x 41 x 32	Waterproof J-Box

DMX CONTROLLER

Part #	Description
011343	100W Digital Controller
011344	180W Digital Controller
011345	720W Digital Controller
011341	Digital Controller & Power Supply Combination
011410	Nicolaude DE3 DMX 512 Controller
011403	Nicolaude DINA-DR1 DMX 512 Controller

Project

Date

220V -60W Dimmable Driver



75W -300W Dimmable Driver



Digital Controller (100W, 180W, 720W)



Nicolaude DE3 DMX 512 Controller



MOUNTINGS & EXTRUSIONS

Mounting Channels to Match any Installation

Aluminum Channel



- High Quality Aluminum
- Lightweight
- Cost Effective

3.25ft (1m) L - #051694

Thickened Plastic Profile



- Plastic Profile 0.12in(3mm) thick
- Lightweight
- Cost Effective
- Rust & Corrosion Resistant

1.38in (35mm) L - #053005

39.37in (1000mm) L - #053004

Specifications may be modified or improved without notification



Aqueon® 3D Diffuse RGB Standard & High Power



CABLE REQUIREMENT

The Aqueon® LED strips need a minimum voltage at the beginning of the LED strip to function according to the specifications. The table below gives an indication of the maximum cable length based on the cable thickness. The standard starter cable is (20 AWG), see table below for max cable lengths. In case the required length is longer than the length mentioned in this cable, it is recommended to cut the starter cable down to 1ft (0.3m) and splice a larger gauge cable. Please contact your distributor for a detailed cable calculation.

Project

Date

Cable X Information	LED Strip	Max. Cable Length
		24V
20 AWG x 2 *Standard	3.28ft / 1m	255ft / 78m
	16.4ft / 5m	45ft / 14m
	32.8ft / 10m	20ft / 6m
	49.2ft / 15m	3ft / 1m
18 AWG x 2	3.28ft / 1m	398ft / 121m
	16.4ft / 5m	71ft / 22m
	32.8ft / 10m	33ft / 10m
	49.2ft / 15m	16ft / 5m
16 AWG x 2	3.28ft / 1m	649ft / 197m
	16.4ft / 5m	115ft / 35m
	32.8ft / 10m	49ft / 15m
	49.2ft / 15m	32ft / 10m
14 AWG x 2	3.28ft / 1m	310ft / 101.8m
	16.4ft / 5m	180ft / 55m
	32.8ft / 10m	78ft / 24m
	49.2ft / 15m	59ft / 18m

WIRING DIAGRAM

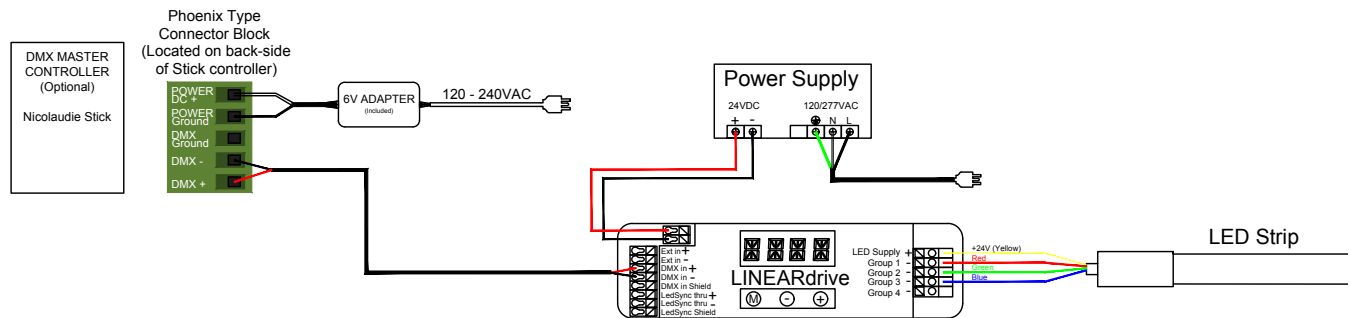

Specifications may be modified or improved without notification

