

OrgaLED® Top DECO, POWER & HIGH POWER

24V DC



Project

Date

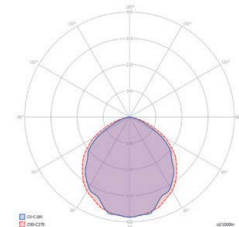

110°

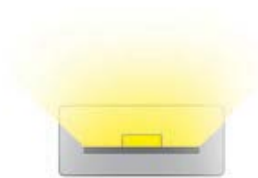

0.5"W x 0.25"H
(12.7mm x 6.35mm)

FEATURES

- Very Flexible (Bend radius >1.2"/30.5mm)
- High Efficacy- 127 lm/W
- High Density- 8 LEDs per cuttable section
- 24V DC - Low Voltage, Class 2
- 66ft(20m) Continuous Runs
- 2700K, 3000K, 3500K, 4000K,5000K
- Field Cuttable 1.96in (49.8mm)
- Dimmable
- UV/IR protected PVC encapsulation
- IP40 or IP67 Wet Location
- UL Listed / CE /ROHS
- 5 years / 50,000 hrs warranty

PART NUMBER & SPECIFICATIONS

OrgaLED® Deco Top

| Part # | Color | CRI | lm/ft | lm/m | Max Run | W/ft | W/m |
|--------|-------|-----|-------|-------|------------|------|------|
| 041101 | 2700K | >94 | 35.1 | 115.1 | 66ft 20.1m | 0.3 | 0.98 |
| 041102 | 3000K | >94 | 36 | 118.1 | 66ft 20.1m | 0.3 | 0.98 |
| 041103 | 3500K | >94 | 36 | 118.1 | 66ft 20.1m | 0.3 | 0.98 |
| 041104 | 4000K | >94 | 38.1 | 125 | 66ft 20.1m | 0.3 | 0.98 |
| 041105 | 5000K | >94 | 38.1 | 125 | 66ft 20.1m | 0.3 | 0.98 |

OrgaLED® Power Top

| Part # | Color | CRI | lm/ft | lm/m | Max Run | W/ft | W/m |
|--------|-------|-----|-------|-------|------------|------|------|
| 041201 | 2700K | >94 | 116.8 | 383.1 | 66ft 20.1m | 1 | 3.28 |
| 041202 | 3000K | >94 | 120.1 | 393.9 | 66ft 20.1m | 1 | 3.28 |
| 041203 | 3500K | >94 | 120.1 | 393.9 | 66ft 20.1m | 1 | 3.28 |
| 041204 | 4000K | >94 | 127 | 416.6 | 66ft 20.1m | 1 | 3.28 |
| 041205 | 5000K | >94 | 127 | 416.6 | 66ft 20.1m | 1 | 3.28 |

OrgaLED® High Power Top

| Part # | Color | CRI | lm/ft | lm/m | Max Run | W/ft | W/m |
|--------|-------|-----|-------|-------|------------|------|------|
| 041301 | 2700K | >94 | 198.6 | 651.4 | 66ft 20.1m | 1.7 | 5.58 |
| 041302 | 3000K | >94 | 204.2 | 669.8 | 66ft 20.1m | 1.7 | 5.58 |
| 041303 | 3500K | >94 | 204.2 | 669.8 | 66ft 20.1m | 1.7 | 5.58 |
| 041304 | 4000K | >94 | 215.9 | 708.2 | 66ft 20.1m | 1.7 | 5.58 |
| 041305 | 5000K | >94 | 215.9 | 708.2 | 66ft 20.1m | 1.7 | 5.58 |

Specifications may be modified or improved without notification



OrgaLED® Top DECO, POWER & HIGH POWER ACCESSORIES



Project

Date

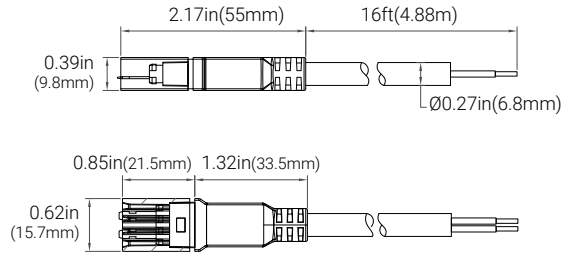

Straight Connector Cable 16ft (4.88m) | IP40 / IP67
#041002

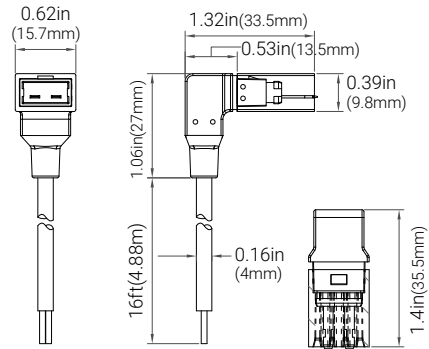

Bottom Feed Connector Cable 16ft (4.88m) | IP40 / IP67
#041003

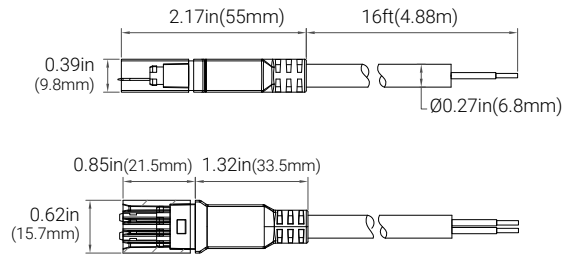

Jumper Cable 8in(203.2mm) | IP40 / IP67
#041004

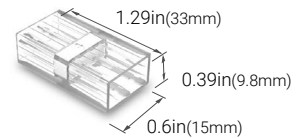
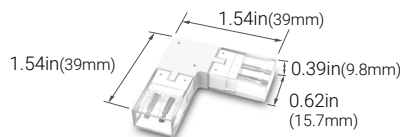
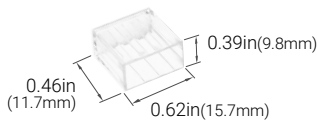

Top End Cap | IP40 / IP67
#041001

L-Splice Connector | IP40 / IP67
#041005

Inline Connector | IP40 / IP67
#041006



PVC IP67 Waterproofing Kit
#011511

IP67 Factory Waterproofing
#011508

Waterproof Mini J-Box
#PC-JBOX

Specifications may be modified or improved without notification



OrgaLED® Top DECO, POWER & HIGH POWER POWER SUPPLIES, MOUNTINGS & EXTRUSIONS

POWER SUPPLIES - 24V

Forward Phase, Reverse Phase, & 0-10V Dimming Drivers. Outdoor enclosures available.

| Part # | Ingress | Voltage | Wattage | Dimensions (inches / mm) | Description |
|--------|---------|----------|---------|------------------------------------|---------------------|
| 045001 | IP67 | 100-305V | 20W | 7.6 x 1.18 x 0.79 / 193 x 30 x 20 | Dimmable LED Driver |
| 045002 | IP67 | 100-305V | 40W | 5.83 x 1.58 x 0.87 / 148 x 40 x 22 | Dimmable LED Driver |
| 045003 | IP67 | 120-277V | 60W | 6.3 x 2.24 x 1.5 / 160 x 57 x 38 | Dimmable LED Driver |
| 045004 | IP67 | 120-277V | 75W | 6.3 x 2.24 x 1.5 / 160 x 57 x 38 | Dimmable LED Driver |
| 045005 | IP67 | 120-277V | 96W | 7.6 x 2.24 x 1.5 / 193 x 57 x 38 | Dimmable LED Driver |
| 045006 | IP67 | 120-277V | 200W | 10.1 x 3.03 x 1.8 / 257 x 77 x 46 | Dimmable LED Driver |
| 045007 | IP67 | 120-277V | 300W | 11.9 x 3.03 x 1.8 / 302 x 77 x 46 | Dimmable LED Driver |

ENCLOSURES

| Part # | Ingress | Dimensions (inches / mm) | Description |
|---------|---------|-------------------------------------|-----------------------|
| 045008 | IP67 | 9.4 x 2.6 x 1.9 / 239 x 66 x 48 | 20W Enclosure |
| 045009 | IP67 | 11.02 x 4.05 x 2.2 / 280 x 103 x 56 | 40W Enclosure |
| 045010 | IP67 | 11.02 x 4.05 x 2.2 / 280 x 103 x 56 | 60W Enclosure |
| 045011 | IP67 | 11.02 x 4.05 x 2.2 / 280 x 103 x 56 | 75W Enclosure |
| 045012 | IP67 | 11.02 x 4.05 x 2.2 / 280 x 103 x 56 | 96W Enclosure |
| 045013 | IP67 | 16.7 x 9.8 x 2.3 / 424 x 249 x 58 | 200W Enclosure |
| 045014 | IP67 | 16.7 x 9.8 x 2.3 / 424 x 249 x 58 | 300W Enclosure |
| PC-JBOX | IP67 | 1.63 x 4.25 x 1.25 / 41 x 108 x 32 | Waterproof Mini J-Box |

MOUNTING & EXTRUSIONS

Mounts directly with brackets, self adhesive transparent channels, or in aluminum extrusions. For more extrusions, visit organiclighting.com.



Aeris is an aluminum anodized IP68 encapsulated extrusion fixture. Can be suspended with low voltage cable suspension or mounted to surface.

- Aeris 0.8"W Low**
0.8" x 0.75" (20 x 19mm)
#010710
- Aeris 0.8"W High**
0.8" x 1.48" (20 x 37.6mm)
#010714
- Aeris 0.8"W Frosted Lens**
#010800



- Aeris 1.2"W Low**
1.2" x 0.75" (30.5 x 19mm)
#010730
- Aeris 1.2"W High**
1.2" x 1.48" (30.5 x 37.6mm)
#010734
- Aeris 1.2"W Frosted Lens**
#010820

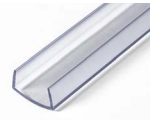

PVC Clear Channel is lightweight and self adhesive.

- PVC Clear Channel 39in (1m)**
.57"W x .31"H (14.5 x 7.9mm)
#041007



Aluminum Channel with an internal groove allows for a flathead screw. OrgaLED sits flush in channel.

- Aluminum Channel**
0.41" x 0.41" (10.4 x 10.4mm)
#012851
- Aluminum Channel Clip**
0.55" x 0.31" (14 x 7.9mm)
#012850



Anodized surface, wall, floor, recess, inverted or suspended mounting.

- 1" Line Extrusion**
0.95" x 2" (24.1 x 50.8mm)
#010982
- 1" Line Frosted Walk-over Lens**
#010959



Anodized surface, wall, floor, recess, inverted or suspended mounting.

- 2" Line Extrusion | 1.73" x 2" (43.9 x 50.8mm)**
#010985
- 2" Line Frosted Walk-over Lens**
#010961
- 2" Line Frosted Decorative Lens**
#010962

Application Based Mounting Systems

Cove Extrusion

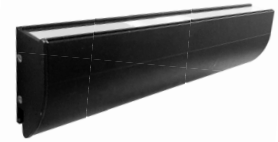

Direct Stair Extrusion Indirect Stair Extrusion

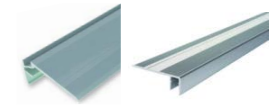

Learn more at OrganicLighting.com

Specifications may be modified or improved without notification

OrgaLED® Top DECO, POWER & HIGH POWER

CABLE REQUIREMENT

The OrgaLED® LED strips need a minimum voltage at the beginning of the LED strip to function according to the specifications. The table below gives an indication of the maximum cable length based on the cable thickness. The standard OrgaLED® starter cable (20 AWG) has a cable length of 16ft(4.88m).

In case the required length is longer than the length mentioned in this cable, it is recommended to cut the starter cable down to 1ft and splice a larger gauge cable. Please contact your distributor for a detailed cable calculation.

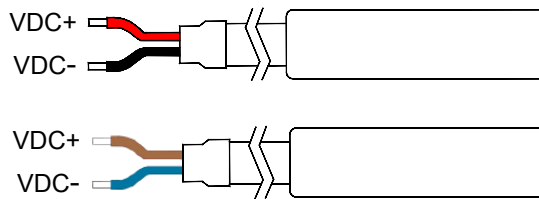

| Cable X Information | LED Strip | Max. Cable Length |
|---------------------|---------------|-------------------|
| | | 24V |
| 20 AWG x 2 | 3.28 ft / 1m | 303 ft / 92.35m |
| | 16.4 ft / 5m | 57 ft / 17.37m |
| | 32.8 ft / 10m | 36 ft / 10.98m |
| | 49.2 ft / 15m | 20 ft / 6.1m |
| | 65.6 ft / 20m | 16 ft / 4.9m |
| 18 AWG x 2 | 3.28 ft / 1m | 457 ft / 139.3m |
| | 16.4 ft / 5m | 86 ft / 26.21m |
| | 32.8 ft / 10m | 56 ft / 17.07m |
| | 49.2 ft / 15m | 35 ft / 10.67m |
| | 65.6 ft / 20m | 25 ft / 7.62m |
| 16 AWG x 2 | 3.28 ft / 1m | 914 ft / 278.6m |
| | 16.4 ft / 5m | 172 ft / 52.43m |
| | 32.8 ft / 10m | 90 ft / 27.43m |
| | 49.2 ft / 15m | 60 ft / 18.3m |
| | 65.6 ft / 20m | 40 ft / 12.2m |
| 14 AWG x 2 | 3.28 ft / 1m | 1521 ft / 463.6m |
| | 16.4 ft / 5m | 287 ft / 87.5m |
| | 32.8 ft / 10m | 140 ft / 42.67m |
| | 49.2 ft / 15m | 96 ft / 29.26m |
| | 65.6 ft / 20m | 70 ft / 21.34m |