

Aqueon® Diffuse Tunable White - Pixel

24V DC 22 - 57

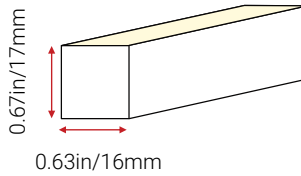

Aqueon Diffuse TW - Pixel is a product that each segment is individually addressable so that you can achieve myriad color changing or animation effects via compatible controller. White tuning allows for changing color of light from warm to neutral to cool for a desirable range in aesthetic. A new standard of flexible light; superior standards new materials, new methods and advanced circuit design to create a flood proof; vibration proof seamless light. Our constant current design ensures to maintain a full illumination in continuous lengths up to 49ft(15m). Available in both vertical and horizontal bending. IP67 or IP68 submersible. Single bin for accurate color rendering, minimal color shift and exceptional color consistency.

FEATURES

- Submersible; UL Listed, 2108
- Horizontal or Vertical bending options
- End to end continuous illumination
- Up to 49.2ft(15m) continuous runs; Flood and vibration proof
- White tuning range from 2200K to 5700K
- Pixel - 3.05W/ft(10W/m) / DMX - 3.66W/ft (12W/m)
- Cuttable every 3.94"(100mm)
- 11.8"(300mm) minimum bending radius
- 5 year limited warranty; 60,000 hr LED lifetime
- Controlled with SPI & DMX
- UV/IR protected Silicone encapsulation
- Ambient working temperature -40°F~140°F(-40°C~60°C)

PART NUMBER & SPECIFICATIONS

Part #	Color	CRI	lm/ft	lm/m	Max Run	W/ft	W/m	
Aqueon® Diffuse Tunable White Pixel - Horizontal Bend								
052223	2200K-5700K	>80	119	390	49.2ft	15m	3.05	10
Aqueon® Diffuse Tunable White Pixel - Vertical Bend								
052224	2200K-5700K	>80	119	390	49.2ft	15m	3.05	10
High Power Aqueon® Diffuse Tunable White Pixel (DMX) - Horizontal Bend								
052225	2200K-5700K	>80	161	530	39.3ft	12m	3.66	12
High Power Aqueon® Diffuse Tunable White Pixel (DMX) - Vertical Bend								
052226	2200K-5700K	>80	195	640	39.3ft	12m	3.66	12

ORGANIC LIGHTING®

Project

Date

ANTI-WICKING

All connections include a ferrule on the power feed to prevent water wicking through the connection point.

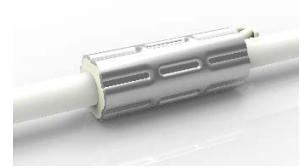

HORIZONTAL BENDING

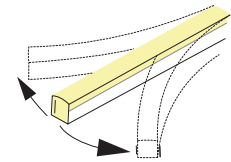

VERTICAL BENDING

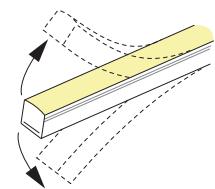

Specifications may be modified or improved without notification

Organic Lighting | 12203 Magnolia Avenue, Suite 1, Riverside CA 92503 | 626.969.6140 | www.organiclighting.com | 10/2024 V6



Aqueon® Diffuse Tunable White - Pixel

CONNECTORS & ACCESSORIES

Factory assembled 3-wired Aqueon Mono IP68 submersible accessories include end caps, extension cords and connectors with customizable cord lengths. IP67 self assembly connectors are also available.

Project

Date

FACTORY ASSEMBLED IP68 CONNECTORS

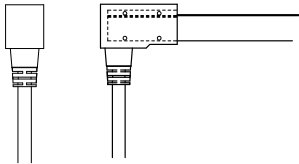

Bottom Feed Connector, 16'L
#052255-CU16

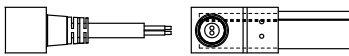

Side Feed Connector, 16'L
#052257-CU16

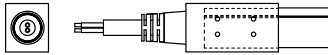

End Connector, 16'L
#052256-CU16

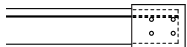

End Cap
#052286

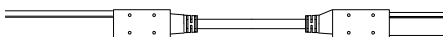

Extension
#052270

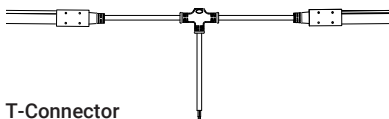

T-Connector
#052272

FIELD ASSEMBLY SNAP ON IP67 CONNECTORS

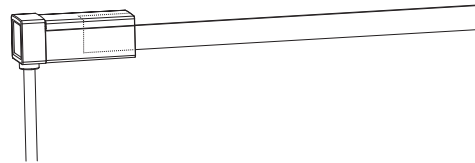

Bottom Snap Connector, 16'L
#052255S-CU16



Side Feed Snap Connector, 16'L
#052257S-CU16

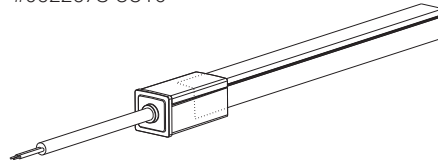

End Snap Connector, 16'L
#052256S-CU16

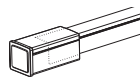

Snap End Cap
#052286S

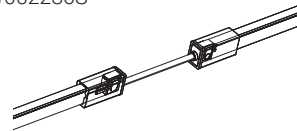

Snap Extension
#052270S

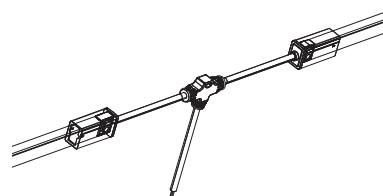

Snap T-Connector
#052272S

Specifications may be modified or improved without notification

Aqueon® Diffuse Tunable White - Pixel

POWER SUPPLIES - 24V

Forward Phase, Reverse Phase, & 0-10V Dimming Drivers. Remote enclosures available.

Part #	Ingress	Voltage	Wattage	Dimensions (inches / mm)	Description
045001	IP67	100-305V	20W	7.6 x 1.18 x 0.79 / 193 x 30 x 20	Dimmable LED Driver
045002	IP67	100-305V	40W	5.83 x 1.57 x 0.87 / 148 x 40 x 22	Dimmable LED Driver
045003	IP67	120-277V	60W	6.3 x 2.24 x 1.5 / 160 x 57 x 38	Dimmable LED Driver
045004	IP67	120-277V	75W	6.3 x 2.24 x 1.5 / 160 x 57 x 38	Dimmable LED Driver
045005	IP67	120-277V	96W	7.6 x 2.24 x 1.5 / 193 x 57 x 38	Dimmable LED Driver
045006	IP67	120-277V	200W	10.1 x 3.03 x 1.8 / 257 x 77 x 46	Dimmable LED Driver
045007	IP67	120-277V	300W	11.9 x 3.03 x 1.8 / 302 x 77 x 46	Dimmable LED Driver

ENCLOSURES

Part #	Ingress	Dimensions (inches / mm)	Description
045008	IP67	9.4 x 2.6 x 1.9 / 239 x 66 x 48	20W Enclosure
045009	IP67	11.02 x 4.05 x 2.2 / 280 x 103 x 56	40W Enclosure
045010	IP67	11.02 x 4.05 x 2.2 / 280 x 103 x 56	60W Enclosure
045011	IP67	11.02 x 4.05 x 2.2 / 280 x 103 x 56	75W Enclosure
045012	IP67	11.02 x 4.05 x 2.2 / 280 x 103 x 56	96W Enclosure
045013	IP67	16.7 x 9.8 x 2.3 / 424 x 249 x 58	200W Enclosure
045014	IP67	16.7 x 9.8 x 2.3 / 424 x 249 x 58	300W Enclosure
PC-JBOX	IP67	4.25 x 1.63 x 1.25 / 108 x 41 x 32	Waterproof J-Box

DMX CONTROLLER

Part #	Description
011343	100W Digital Controller
011344	180W Digital Controller
011345	720W Digital Controller
011341	Digital Controller & Power Supply Combination
011410	Nicolaude DE3 DMX 512 Controller
011403	Nicolaude DINA-DR1 DMX 512 Controller
050203	LT-200 SPI Controller - For Pixel
050205	DMX512 SPI Converter Decoder - For Pixel
050210	DiGidot C4 Extended - DMX/SPI Controller
050211	DiGidot PxLNet Transmitter

MOUNTINGS & EXTRUSIONS

Mounting Channels to Match any Installation

Aluminum Profile



- High Quality Aluminum
- Lightweight
- Cost Effective
- Warp/corrosion resistant

1.38in(35mm) L - #053001
39.37in(1000mm) L - #053000

Flanged Aluminum Profile



- High Quality Aluminum
- Lightweight
- Cost Effective
- Flange for Recessed Installation

1.38in(35mm) L - #053003
39.37in(1000mm) L - #05302

Flanged Internal Serrated Aluminum Profile



- Lightweight
- Easy to Install & Dismantle
- Continuous & Strong Gripping
- Flange for Recessed Installation

0.79in(20mm) L - #053011
39.37in(1000mm) L - #053010

Internal Serrated Aluminum Profile



- Continuous & Strong Gripping
- Lightweight
- Easy to Install & Dismantle
- For Suspended Installations

0.79in(20mm) L - #053009
39.37in(1000mm) L - #053008

Bendable Serrated Aluminum Profile



- High Quality Aluminum
- Easy to Install & Dismantle
- Continuous & Strong Gripping
- Memory Retaining
- Perfect for Curved Installations

19.68in(500mm) L - #053013
39.37in(1000mm) L - #053012

Thickened Plastic Profile



- Plastic Profile 0.12in(3mm) thick
- Lightweight
- Cost Effective
- Rust & Corrosion Resistant

1.38in(35mm) L - #053005
39.37in(1000mm) L - #053004



Project

Date

20W -60W Dimmable Driver



75W -300W Dimmable Driver



Digital Controller (100W, 180W, 720W)



Nicolaude DE3 DMX 512 Controller



Specifications may be modified or improved without notification



CABLE REQUIREMENT

Cable X Information	LED Strip	Max. Cable Length
		24V
*18 AWG *standard	3.28 ft / 1m 16.4 ft / 5m 32.8 ft / 10m 49.2 ft / 15m	159ft / 48m 32ft / 10m 18ft / 5.5m 11.5ft / 3.5m
16 AWG	3.28 ft / 1m 16.4 ft / 5m 32.8 ft / 10m 49.2 ft / 15m	260ft / 79m 52ft / 16m 29.5ft / 9m 20ft / 6m
14 AWG	3.28 ft / 1m 16.4 ft / 5m 32.8 ft / 10m 49.2 ft / 15m	416ft / 127m 82ft / 25m 47.5ft / 14.5m 101.7ft / 31m

The Aqueon® LED strips need a minimum voltage at the beginning of the LED strip to function according to the specifications. The table below gives an indication of the maximum cable length based on the cable thickness. The standard Aqueon® starter cable is (18 AWG), see table below for max cable lengths.

In case the required length is longer than the length mentioned in this cable, it is recommended to cut the starter cable down to 1ft (0.3m) and splice a larger gauge cable. Please contact your distributor for a detailed cable calculation.

ELECTRICAL DETAILS

Pixel / Single-end Feed

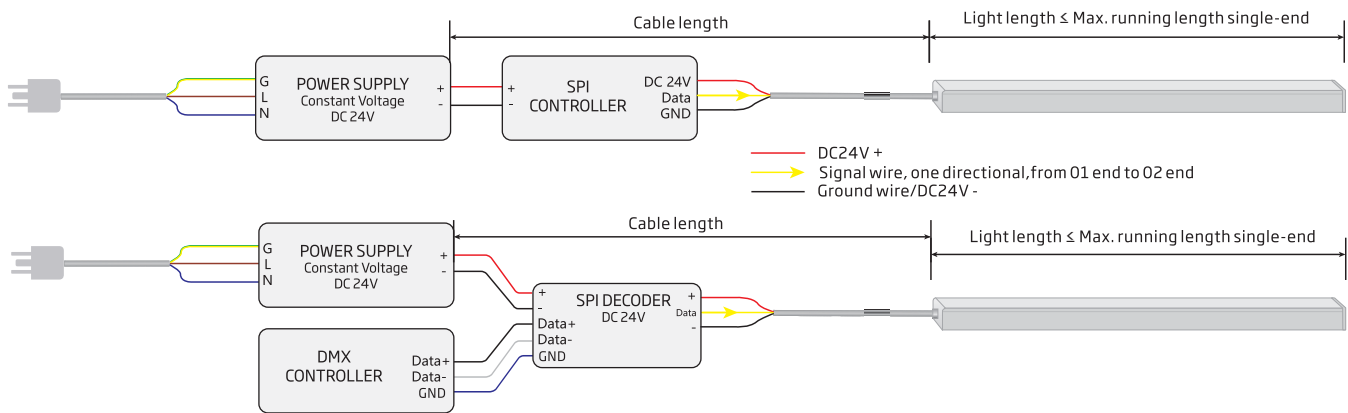

(DMX) Pixel / Single-end Feed

