

USER MANUAL

OrgaLED® Top Deco, Power, High Power



Table of Contents

Basic Parameters	02
General	03
Cautions	04
Cutting Instructions	05
Starter Cable Connector	07
End Cap	08
Waterproofing	09
Mounting Installation	10
Requirements & Cautions for Installation of Mounting profile	12
Waterproof Mini J-box Installation	13
Troubleshooting	14
Electrical Details	15
Loading Chart	16

PLEASE READ THESE INSTRUCTIONS CAREFULLY BEFORE INSTALLATION & LEAVE A COPY FOR THE END USER/ MAINTANANCE ENGINEER FOR FUTURE REFERENCE.

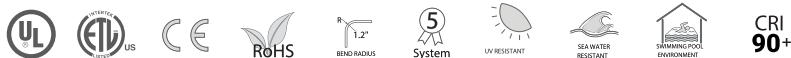

Specifications may be modified or improved without notification

WARNING

This product comes with a 5 year warranty.

Warranty Void if:

1. The installation guide has not been consulted (installation mistake).
2. The installation is not done by a certified installer.
3. Local rules and guidelines are not respected.
4. The invoice cannot be shown and/or has been altered.
5. Damage is caused by negligence, abnormal use or improper handling, use, maintenance and/or cleaning of the product.

This product is intended for professional use only! This product must be installed by a qualified and certified installer according to local rules and guidelines. Organic Lighting Systems, Inc. cannot be held liable for (consequential) damage and/or injuries due to unintended use and/or installation errors.

PRODUCT DESCRIPTION

The OrgaLED® LED strip is a high quality, flexible LED strip with a unique co-extrusion technology. Designed for an endless range of indoor and outdoor applications. For use in wet environments, must use IP67 connectors and cords must terminate in a dry area or be sealed in an IP67 approved compartment.

BASIC PARAMETERS

1. Dimensions: 0.5"W x 0.25"H (12.7mm x 6.35mm)
2. **Min. bend diameter: 1.18" (30mm). Solely bend up or downward**
Do not compress, stretch or bend the LED strip.
3. Protection rate: IP67/IP40
4. The product IP rate is ultimately in line with properly applied IP Rated connectors.
5. Easy to use, with a range of accessories for joining, terminating, mounting & powering.
6. Long lifetime: 5 years.
7. Environmental Working Temperature: -20°C~45°C.
8. Environmental Installation Temperature: 0°C~45°C.



0.5"W x 0.25"H
(12.7mm x 6.35mm)

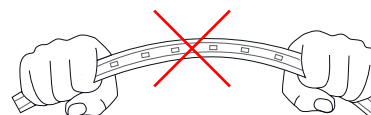
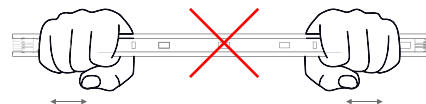
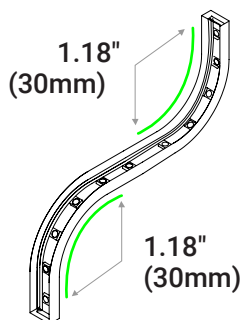

GENERAL

Read the instructions and safety precautions before installation, usage and storage of the products to secure safety of the user and reliability of the product. Hand over the instructions to the end-user and/or those responsible for installation, maintenance and usage.

Organic Lighting Systems, Inc. cannot be held responsible for improper handling, product installation, usage or storage.

HANDLING

- Handle with care.
- The product may not be modified or converted otherwise than prescribed.
- Products are transported in proper packaging. Products should remain packed until installation.

INSTALLATION

- Attention: The power has to be switched off the main power supply or the connection before installation. Not doing so may damage the product.
- Use a suitable LED power supply/driver: 24V DC constant voltage. Do not drive the product on other voltages than described in their datasheet/products specifications.
- Installation has to be done by a certified professional with knowledge of electrical circuits or a specialised maintenance person with valid directives.
- General and local construction, safety and installation regulations should be respected.
- Use only supplied parts, accessories and required tools as prescribed in the installation manual to guarantee a safe installation and use of the product.
- Products may solely be installed in the areas according to their prescribed IP-rating, IK-rating, temperature range and chemical resistances.
- Do not fasten anything on the product, same applies for hanging.

Do not install the product in the following cases:

- Damage is visible on the product or its cables.
- The inside of the product is moistened or dirty.
- The product or its cables have been modified. It could lead to an electrical shock or a short circuit may occur.
- Children may not play unsupervised with electrical products as they cannot judge the dangers in dealing with electrical circuits correctly.

OPERATION & USE

Solely use the product when it's working correctly. If not, switch the power off immediately and advise an electrical specialist in the following cases:

- Damage is visible on the product.
- The product does not function.
- Smoke or steam rises from the product.
- Crackling sounds are noticeable.
- The product is overheating.
- Repairs on the installation may only be performed by qualified electricians. Product repairs may solely be done by Organic Lighting Systems, Inc.

CLEANING & MAINTANENCE

Attention: Disconnect the power before maintenance and cleaning.

- Dust and dirt accumulated over time should be removed from the light-emitting surface to assure optimal functioning of the product.
- Paints, solvents and corrosive cleaning chemicals may not contact and thus affect the product.

ENVIRONMENT & WASTE

- Exterior decorative lighting should only be used after sunset.
- This product may not be treated as household waste. Dispose of the material through the waste recycling of electrical and electronic equipment.

CAUTIONS

1. Before making any cuts, installation, maintenance or connection, be sure the mains are disconnected!
2. Note: all connector joints must be connected correctly to achieve IP67 rating.
3. Please follow instructions to install flexible LED strip, and confirm the working voltage; It must match the product requirements.
4. Please confirm the polarity of connector before inserting Starter Cable connector.
5. Connect and cut product correctly. Any wrong installation will damage this product.
6. Use qualified DC power supply.
7. Please correctly use and bend this flex LED strip, see the figures on the right.
8. Do not operate light when ambient temperature exceeds the range of specified temperature in User Manual (page 2).
9. Do not power the light over 30 minutes in coil packaging.
10. Do not mix the four colors (R,G,B,W) in full load simultaneously.

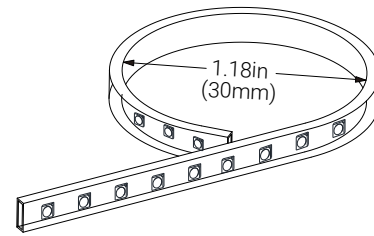

Do not bend smaller than allowed.
Minimum bend diameter 1.18in (30mm).

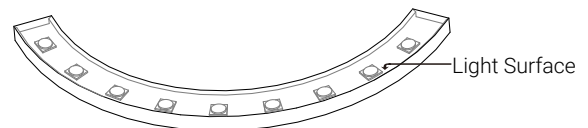
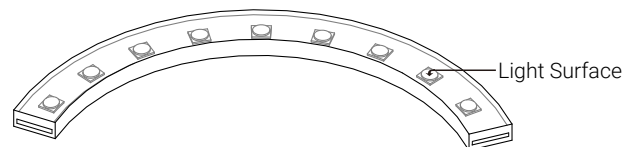
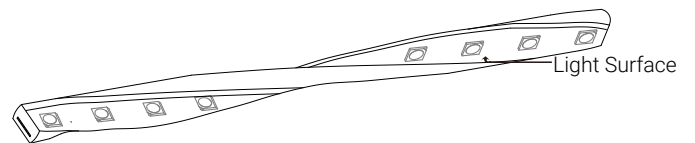
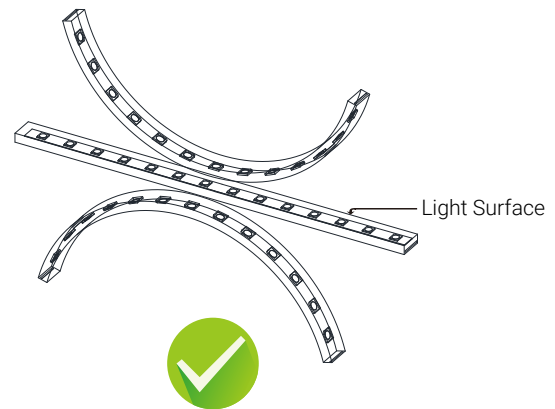

Warning: The above wrong approaches will damage the product.

CUTTING INSTRUCTIONS

NOTE

1. Place the light horizontally when cutting it.
2. Use only factory recommended cutting tool.
3. Cut the light according to the following instructions. Incorrect operation will damage the light.



8 LED = 1 Unit
1 Unit = 1.9685in(50mm)

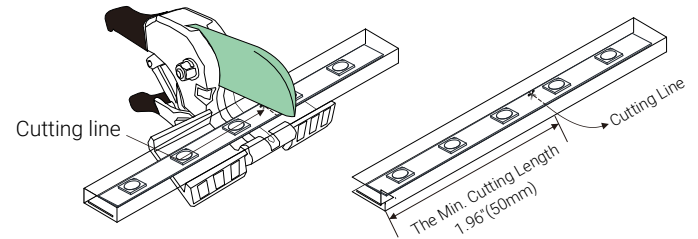

Cut the light only at printed cutting line with printing mark face upwards

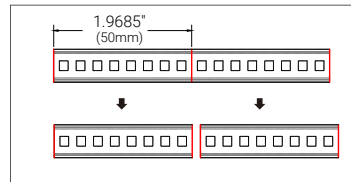

The cutting surface must be flush and smooth.

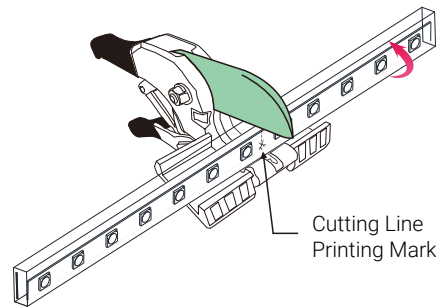

Printing mark should be faced upwards

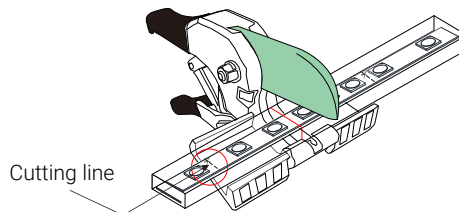

Cutting can only be made at the printed cutting line.

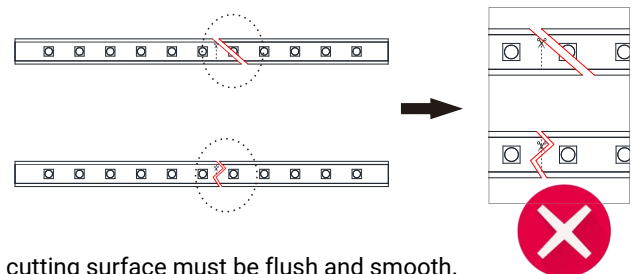

The cutting surface must be flush and smooth.

WARNING: The above mishandling will damage the light.

STARTER CABLE CONNECTOR

Please ignore these steps if the starter connector has been assembled before delivery.

NOTE

1. Never wet the assembly units or assemble with wet hands.
2. Please use the tools correctly.

Tools

Micro slotted screwdriver

Installation Steps

See page 6.

Straight

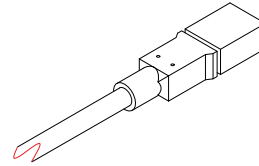

Bottom Feed

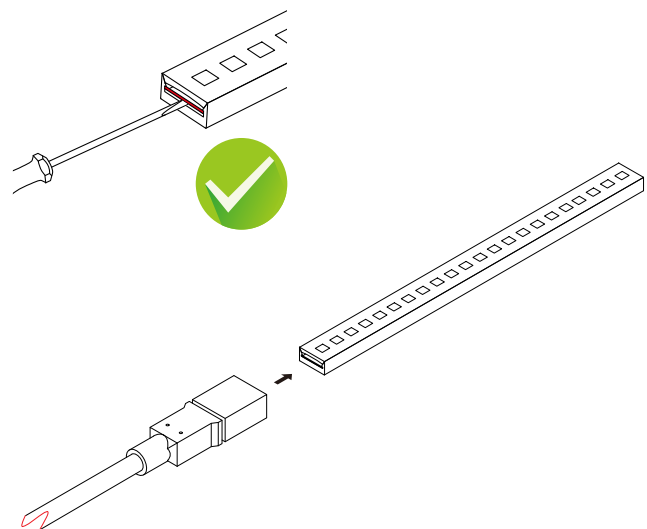
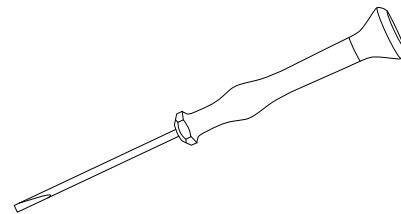
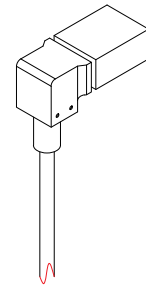

STARTER CABLE CONNECTOR

1. Insert Micro Slotted Screwdriver in Cavity for Starter Connector.

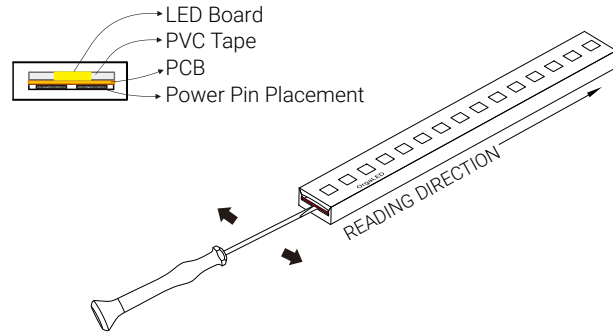

NEVER insert into the TOP side (LED side) of the PCB
Make sure the LED is facing in the right direction.

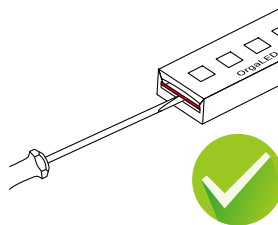

Insert the screw driver into the **bottom** side of PCB

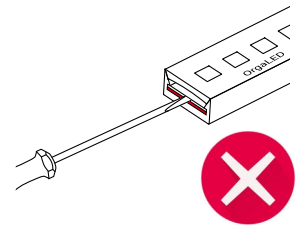

It will damage the light if insert into the top side of PCB

2. Insert the Starter Connector.

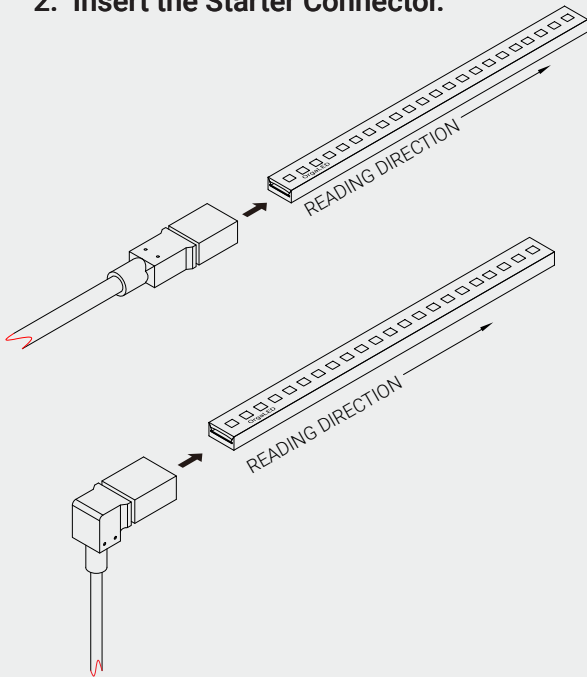

Insert the power pins into the cavity that you created (bottom side of PCB)

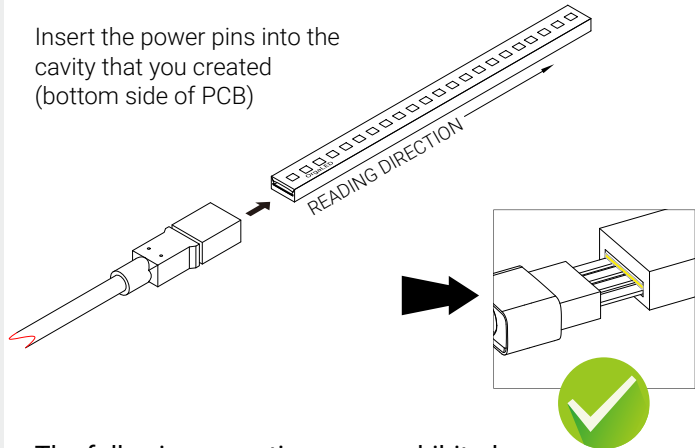

The following operations are prohibited:

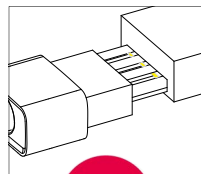

Inserting into the top side of the PCB

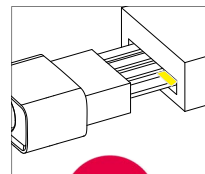

Inserting crosswire into the PCB

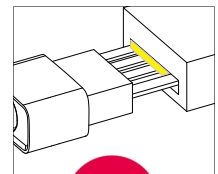

Inserting crosswire into the PCB

END CAP

Please ignore these steps if the end cap has been assembled before delivery.

NOTE

1. Never wet the assembly units or assemble with wet hands.
2. Please use the tools correctly.
3. Please pay attention to personal security when using tools.

Installation Steps

1. Insert End Cap onto end of LED strip until it sits flush.

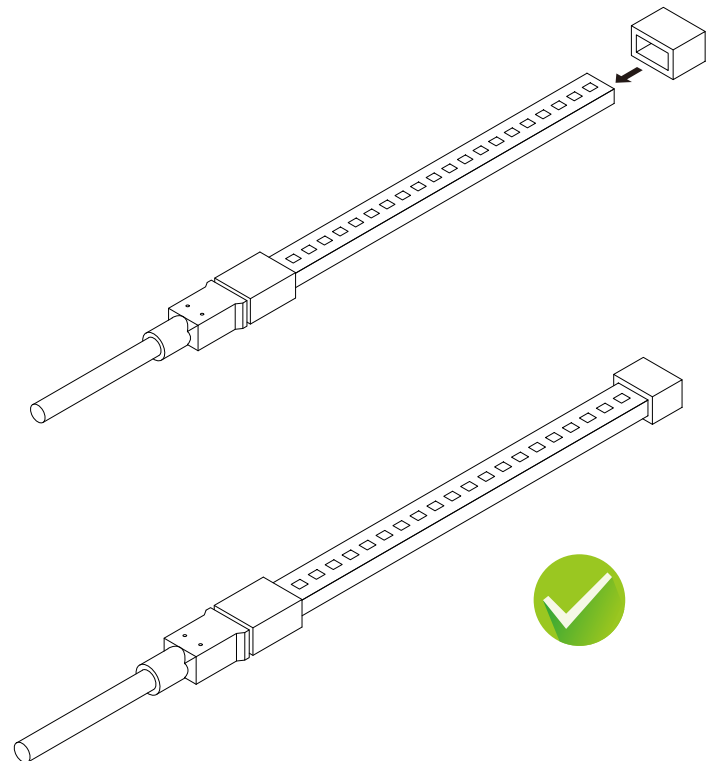
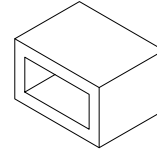

WATERPROOFING

Please ignore these steps if the LED Strip has been waterproofed before delivery.

NOTE

1. Never wet the assembly units or assemble with wet hands.
2. Please use the tools correctly.
3. Please pay attention to personal security when using tools.
4. Wear the gloves and safety glasses before waterproofing.

Installation Steps

1. After properly assembling the LED Tape Light, position vertically and keep still. Place nozzle inside plastic housing and fill it up with UV Glue.
2. Follow the same procedure for the end cap.
3. Use UV flash light around the transparent plastic housing to cure. Follow the same procedure for the end cap.

Minimum Cure Time: 5 minutes



Kit Includes:
UV Glue, UV Flash Light, Gloves and UV Safety Glasses.

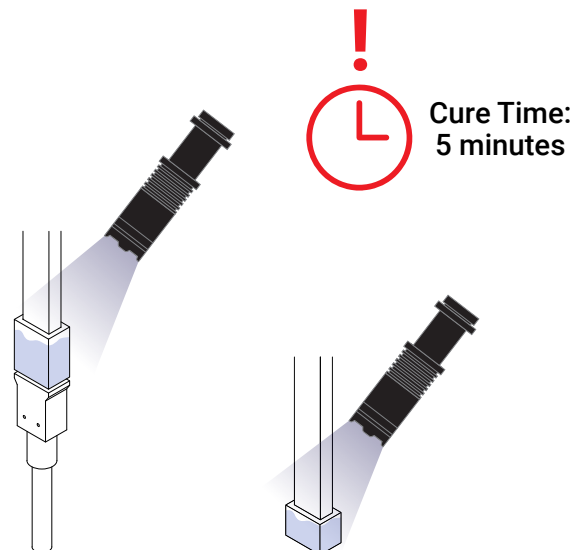
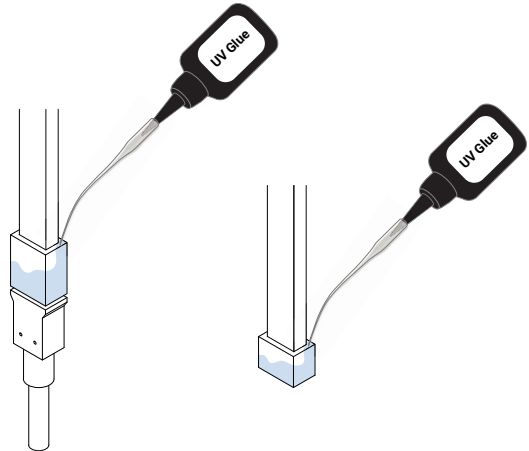

MOUNTING INSTALLATION

Installation Guide

1. Prepare for Installation

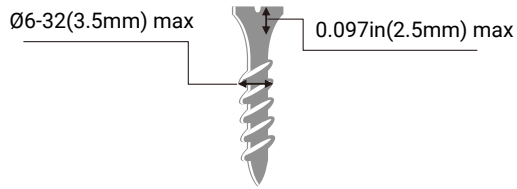

Screw



Screwdriver

or



Electric Screwdriver

2. Correct installation of standard Aluminum Profile

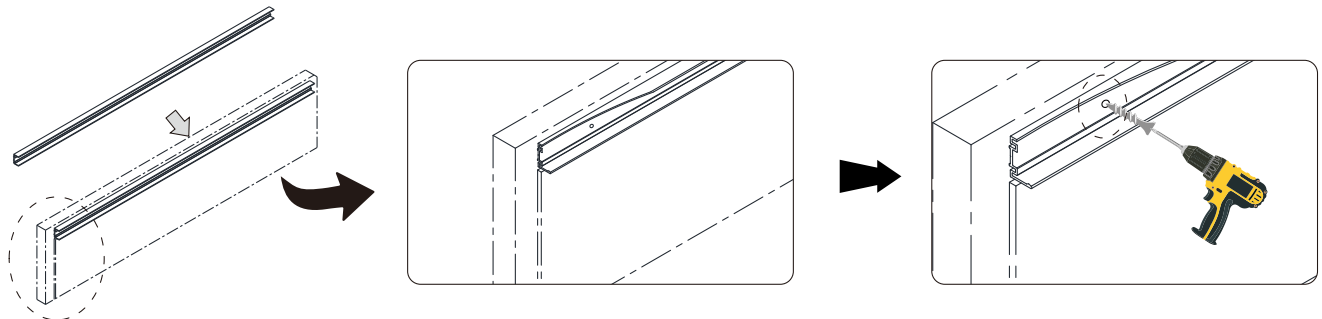

REQUIREMENTS & CAUTIONS FOR INSTALLATION OF MOUNTING PROFILE

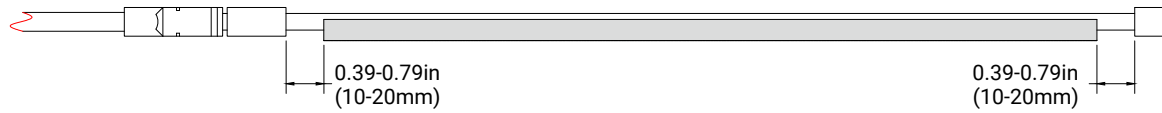

Make sure the cable is free from any mechanical stress.
Keep 0.39-0.79in (10-20mm) distance between the connector and the end of aluminum profile.



Do not cause mechanical stress on front connector cable.

Do not curl or pull the front connector cable with excessive force.

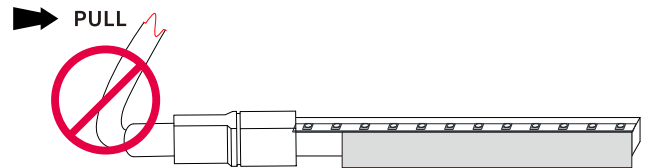
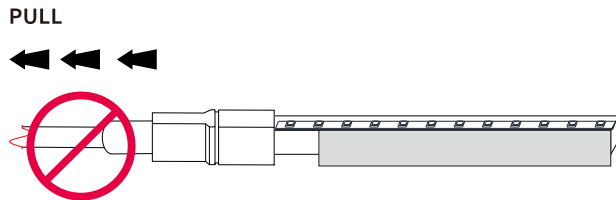

Do not install the connector on the aluminum profile and make light deformation.

Do not install LED with the space between the connector and aluminum profile being less than 0.39in (10mm).

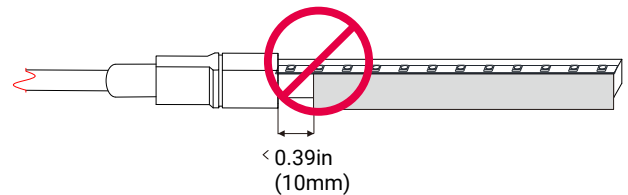
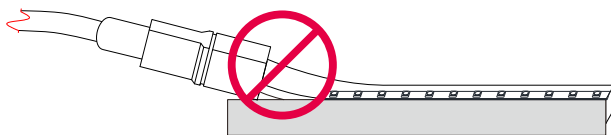

Install light in one direction. Don't let it bunch in middle.

REQUIREMENTS & CAUTIONS FOR INSTALLATION OF MOUNTING PROFILE

Bending in the Process of Installation

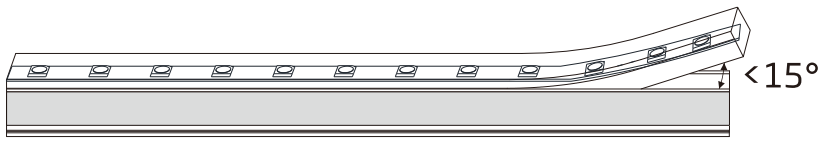

Installing angle should not exceed 15 degrees when pressing the light to the aluminum profile by hand.

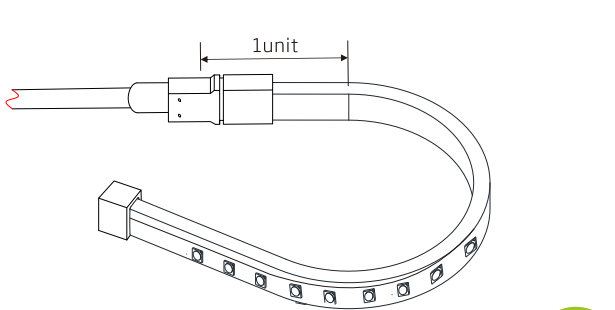

Please avoid bending at the first unit of the light.

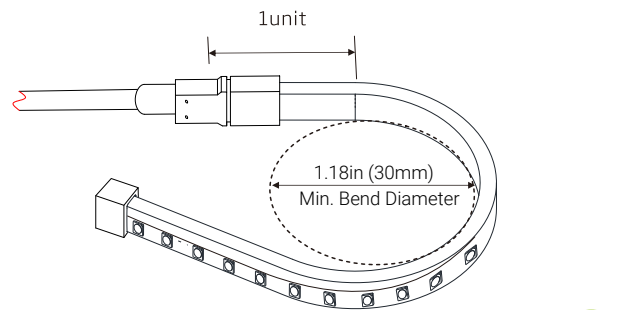

The light can bend in defined min. bending diameter or larger.

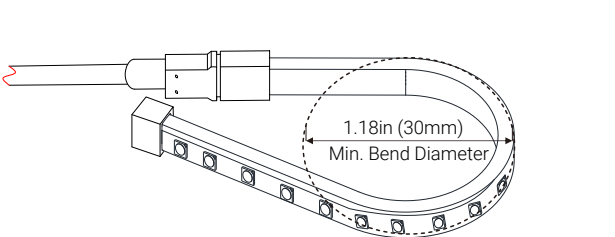

The circuit board and LEDs could be damaged if bending diameter is tighter than defined min. bending diameter.

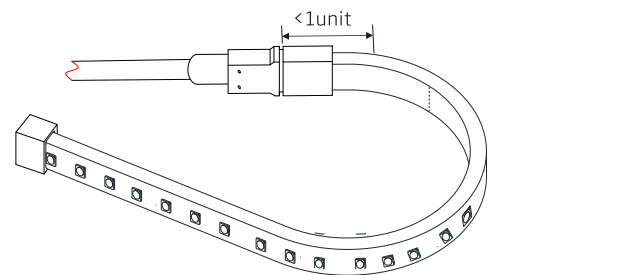

Do not bend against the first or last unit of the light.

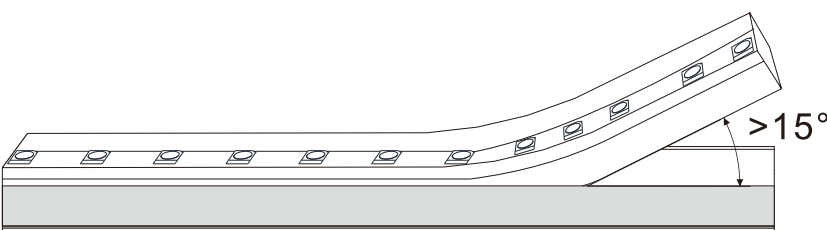

The circuit board could be damaged if installing angle larger than 15 degree.

WATERPROOF MINI JUNCTION BOX INSTALLATION

Dimensions: 1.63"W x 4.25"L x 1.25"H
(41x108x32mm)

Cable Diameter: 0.16"-0.31" (4-8mm)

Quick Connector Voltage: 16A/450V

Ingress: IP67



Installation:

1. Measure orifice.



2. Install wires.

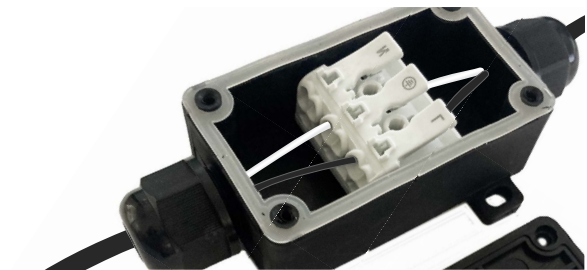

3. Tighten the connector.

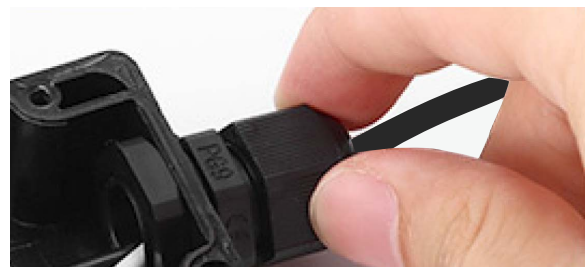

4. Cover the panel and secure with screws.



TROUBLESHOOTING

The entire LED doesn't work.

- Check power supply is plugged in, switched on and receiving power.
- Check all light, dimmer or controller connections connection from the power supply to LED strip.
- Check polarity of all wire connections.
- Make sure power supply output voltage is 24V DC.
- Check connector is properly assembled.

Light emitting appears dim or dull at one end.

- Check whether the output voltage of the power supply is lower than that of light.
- Adjust the dimming level to the maximum.

Light emitting excessive brightness.

- Check whether the output voltage of power supply is higher than that of light.
- Check whether the power grid is stable.

If the first segment doesn't work.

- Cut made is not in indicated cutting line or not in a straight line: Cut out and remove the first segment.
- Damage caused to the first LED when inserting the connector on the top side of PCB: Cut out the first segment and properly assemble connector.
- Water ingress due to poor connector assembly could cause a short circuit of first segment: Replace length with a new one.
- External impact damage inside LEDs: Only use your hands to install into mounting channels.

LED is flashing on and off.

- Check the power supply to ensure it supports the length you are using. Select the appropriate strength or install an additional power supply to support your installation.
- Check power supply output voltage is stable.
- Check connector is properly installed with good contact with the copper PCB.
- Check proper controller is connected.

ELECTRICAL DETAILS

WIRING DIAGRAM

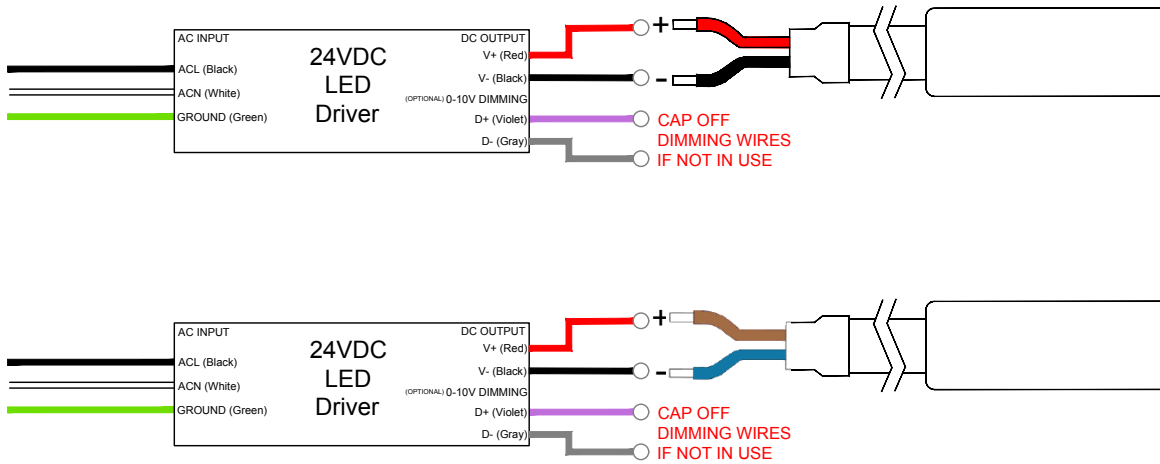

CABLE REQUIREMENT

The OrgaLED® LED strips need a minimum voltage at the beginning of the LED strip to function according to the specifications. The table below gives an indication of the maximum cable length based on the cable thickness. The standard OrgaLED® starter cable (20 AWG) has a cable length of 16ft(4.88m).

In case the required length is longer than the length mentioned in this cable, it is recommended to cut the starter cable down to 1ft and splice a larger gauge cable. Please contact your distributor for a detailed cable calculation.

Cable X Information	LED Strip	Max. Cable Length
		24 V
20 AWG x 2	3.28 ft / 1m	303 ft / 92.35m
	16.4 ft / 5m	57 ft / 17.37m
	32.8 ft / 10m	36 ft / 10.98m
	49.2 ft / 15m	20 ft / 6.1m
	65.6 ft / 20m	16 ft / 4.9m
18 AWG x 2	3.28 ft / 1m	457 ft / 139.3m
	16.4 ft / 5m	86 ft / 26.21m
	32.8 ft / 10m	56 ft / 17.07m
	49.2 ft / 15m	35 ft / 10.67m
	65.6 ft / 20m	25 ft / 7.62m
16 AWG x 2	3.28 ft / 1m	914 ft / 278.6m
	16.4 ft / 5m	172 ft / 52.43m
	32.8 ft / 10m	90 ft / 27.43m
	49.2 ft / 15m	60 ft / 18.3m
	65.6 ft / 20m	40 ft / 12.2m
14 AWG x 2	3.28 ft / 1m	1521 ft / 463.6m
	16.4 ft / 5m	287 ft / 87.5m
	32.8 ft / 10m	140 ft / 42.67m
	49.2 ft / 15m	96 ft / 29.26m
	65.6 ft / 20m	70 ft / 21.34m

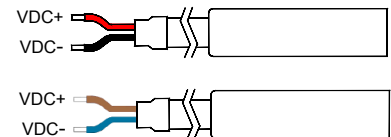

Specifications may be modified or improved without notification

LOADING CHART

These are the light maximum recommended running length subject to selected power supply.

Type	Rated Power	Power Supply					
		20w	40w	60w	75w	96w	200w
DECO	0.3w/ft (0.98w/m)	45ft(13.8m)	95ft(29m)	135ft(41.1m)	168ft(51.2m)	216ft(65.8m)	450ft(137.2m)
POWER	1w/ft (3.3w/m)	18ft(5.5m)	36ft(11m)	54ft(16.5m)	67ft(20.4m)	86ft(26.2m)	180ft(54.9m)
HP	1.7w/ft (5.6w/m)	10.5ft(3.2m)	21ft(6.4m)	31.7ft(9.7m)	39.7ft(12.1m)	50.8ft(15.5m)	100ft(30.5m)