



■ Features :

- Universal AC input / Full range (up to 295VAC)
- Built-in active PFC function
- High efficiency up to 91%
- Protections: Short circuit / Over current / Over voltage / Over temperature
- Cooling by free air convection
- OCP point adjustable through output cable or internal potentiometer
- IP65 / IP67 design for indoor or outdoor installations
- Suitable for LED lighting and moving sign applications
- Compliance to worldwide safety regulations for lighting
- 3 years warranty



CLG-150-12 [A] Blank : IP67 rated. Cable for I/O connection.
 A : IP65 rated. Output voltage and constant current level can be adjusted through internal potentiometer.
 B : IP67 rated. Constant current level adjustable through output cable.
 C : Terminal block for I/O connection. Output voltage and constant current level can be adjusted through internal potentiometer.

SPECIFICATION

MODEL	CLG-150-12	CLG-150-15	CLG-150-20	CLG-150-24	CLG-150-30	CLG-150-36	CLG-150-48	
OUTPUT	DC VOLTAGE	12V	15V	20V	24V	30V	36V	48V
	CONSTANT CURRENT REGION Note.4	9 ~ 12V	11.25 ~ 15V	15 ~ 20V	18 ~ 24V	22.5 ~ 30V	27 ~ 36V	36 ~ 48V
	RATED CURRENT	11A	9.5A	7.5A	6.3A	5A	4.2A	3.2A
	RATED POWER	132W	142.5W	150W	151.2W	150W	151.2W	153.6W
	RIPPLE & NOISE (max.) Note.2	150mVp-p	150mVp-p	150mVp-p	150mVp-p	150mVp-p	150mVp-p	200mVp-p
	VOLTAGE ADJ. RANGE Note.6	9 ~ 13V	13 ~ 17V	17 ~ 22V	22 ~ 27V	26 ~ 32V	31 ~ 41V	40 ~ 56V
	CURRENT ADJ. RANGE	Can be adjusted by internal potentiometer A type and C type only						
		5.5 ~ 11A	4.75 ~ 9.5A	3.75 ~ 7.5A	3.15 ~ 6.3A	2.5 ~ 5A	2.1 ~ 4.2A	1.6 ~ 3.2A
	VOLTAGE TOLERANCE Note.3	±2.0%	±2.0%	±2.0%	±1.0%	±1.0%	±1.0%	±1.0%
	LINE REGULATION	±0.5%	±0.5%	±0.5%	±0.5%	±0.5%	±0.5%	±0.5%
LOAD REGULATION	±1.0%	±1.0%	±1.0%	±0.5%	±0.5%	±0.5%	±0.5%	
SETUP, RISE TIME	3000ms, 80ms/115VAC 500ms, 80ms/230VAC at full load							
HOLD UP TIME (Typ.)	50ms / 230VAC 16ms / 115VAC at full load							
INPUT	VOLTAGE RANGE Note.5	90 ~ 295VAC		127 ~ 417VDC				
	FREQUENCY RANGE	47 ~ 63Hz						
	POWER FACTOR (Typ.)	PF>0.98/115VAC, PF>0.95/230VAC, PF>0.93/277VAC at full load (Please refer to "Power Factor Characteristic" curve)						
	TOTAL HARMONIC DISTORTION	THD< 20% when output loading≥75% at 115VAC/230VAC input and output loading≥75% at 277VAC input						
	EFFICIENCY (Typ.)	88%	88%	90%	90%	91%	91%	91%
	AC CURRENT (Typ.)	2A / 115VAC	1A / 230VAC	0.68A / 277VAC				
	INRUSH CURRENT(max.)	COLD START 65A (width=595μs measured at 50% Ipeak) at 230VAC						
	MAX. No. of PSUs on 16A CIRCUIT BREAKER	3 units (circuit breaker of type B) / 5 units (circuit breaker of type C) at 230VAC						
LEAKAGE CURRENT	<1mA / 240VAC							
PROTECTION	OVER CURRENT (Typ.) Note.4	95 ~ 108% Protection type : Constant current limiting, recovers automatically after fault condition is removed						
	SHORT CIRCUIT	Hiccup mode, recovers automatically after fault condition is removed						
	OVER VOLTAGE	13.5 ~ 17V	18 ~ 23V	23 ~ 28V	28 ~ 34V	33 ~ 39V	42 ~ 50V	59 ~ 70V
	OVER TEMPERATURE	Shut down o/p voltage, re-power on to recover						
ENVIRONMENT	WORKING TEMP.	-30 ~ +70°C (Refer to "Derating Curve")						
	WORKING HUMIDITY	20 ~ 95% RH non-condensing						
	STORAGE TEMP., HUMIDITY	-40 ~ +80°C, 10 ~ 95% RH						
	TEMP. COEFFICIENT	±0.03%/°C (0 ~ 50°C)						
SAFETY & EMC	VIBRATION	10 ~ 500Hz, 5G 12min./1cycle, period for 72min. each along X, Y, Z axes						
	SAFETY STANDARDS Note.7	UL8750, CSA C22.2 No. 250.0-08, UL1012, CAN/CSA-C22.2 No. 107.1-01, UL879, CSA C22.2 No.207-M89, EN61347-1, EN61347-2-13 independent (except for CLG-150 C type), UL60950-1, TUV EN60950-1, IP65 or IP67, J61347-1 (except for CLG-150 C type), J61347-2-13 approved						
	WITHSTAND VOLTAGE	I/P-O/P:3.75KVAC	I/P-FG:2KVAC	O/P-FG:0.5KVAC				
	ISOLATION RESISTANCE	I/P-O/P, I/P-FG, O/P-FG:100M Ohms / 500VDC / 25°C / 70% RH						
	EMC EMISSION	Compliance to EN55015, EN55022 (CISPR22) Class B, EN61000-3-2 Class C (≥75% load) ; EN61000-3-3						
OTHERS	EMC IMMUNITY	Compliance to EN61000-4-2,3,4,5,6,8,11, EN61547, EN55024, light industry level (surge 4KV), criteria A						
	MTBF	303.7K hrs min. MIL-HDBK-217F (25°C)						
	DIMENSION	222.2*68*38.8mm (L*W*H)(CLG-150-Blank/A/B)			229*68*38.8mm (L*W*H)(CLG-150-C)			
NOTE	PACKING	1.0Kg; 12pcs/13Kg/0.58CUFT(CLG-150-Blank/A/B)			1Kg; 12pcs/13Kg/0.96CUFT(CLG-150-C)			
		1. All parameters NOT specially mentioned are measured at 230VAC input, rated load and 25°C of ambient temperature. 2. Ripple & noise are measured at 20MHz of bandwidth by using a 12" twisted pair-wire terminated with a 0.1uf & 47uf parallel capacitor. 3. Tolerance : includes set up tolerance, line regulation and load regulation. 4. Please refer to "DRIVING METHODS OF LED MODULE". 5. Derating may be needed under low input voltages. Please check the static characteristics for more details. 6. A type and C type only. 7. Safety and EMC design refer to EN60598-1, subject 8750(UL), CNS15233, GB7000.1, FCC part18. 8. The power supply is considered as a component that will be operated in combination with final equipment. Since EMC performance will be affected by the complete installation, the final equipment manufacturers must re-qualify EMC Directive on the complete installation again. 9. To fulfill requirements of the latest ErP regulation for lighting fixtures, this LED power supply can only be used behind a switch without permanently connected to the mains.						

Mechanical Specification

Case No. 954A Unit:mm

Blank:(CLG-150)

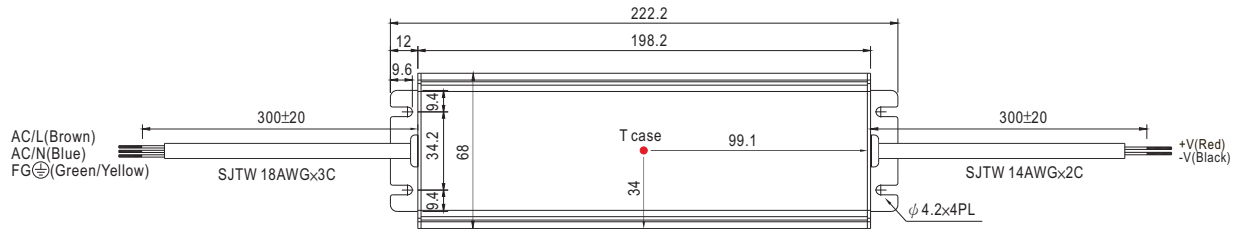

※ T case: Max. Case Temperature.



※IP67 rated. Cable for I/O connection.

A Type:(CLG-150-_A)

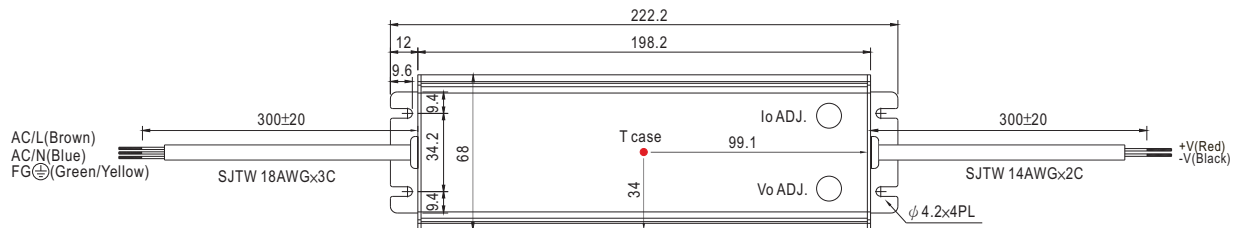

※ T case: Max. Case Temperature.



※ IP65 rated. Output voltage and constant current level can be adjusted through internal potentiometer.
(Can access by removing the rubber stopper on the case.)

B Type:(CLG-150-_B)

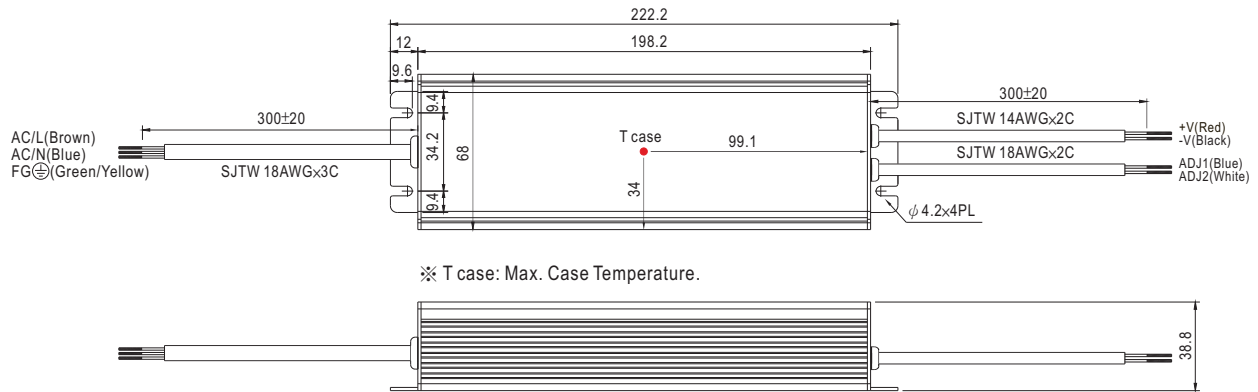

※ T case: Max. Case Temperature.

※ IP67 rated. Output constant current level can be adjusted through output cable by connecting a resistor between ADJ1 and ADJ2.

※ Reference resistance value for output current adjustment (Typical)

Resistance	Percentage of rated current
Open	Slightly > 100%
4.7KΩ	100%
620Ω	75%
82Ω	50%
Short	Slightly < 50%

C Type:(CLG-150-_C)

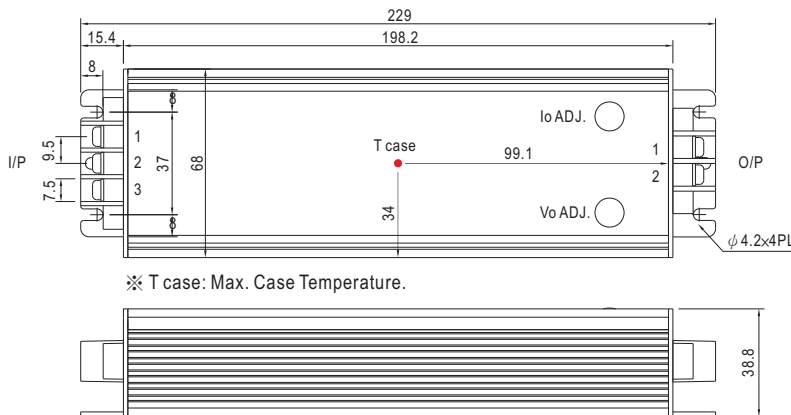

※ T case: Max. Case Temperature.

AC Input Terminal Pin No. Assignment

Pin No.	Assignment
1	FG ≐
2	AC/N
3	AC/L

DC Output Terminal Pin No. Assignment

Pin No.	Assignment
1	+V
2	-V

※ Output voltage and constant current level can be adjusted through internal potentiometer. (Can access by removing the rubber stopper on the case.)

■ Block Diagram

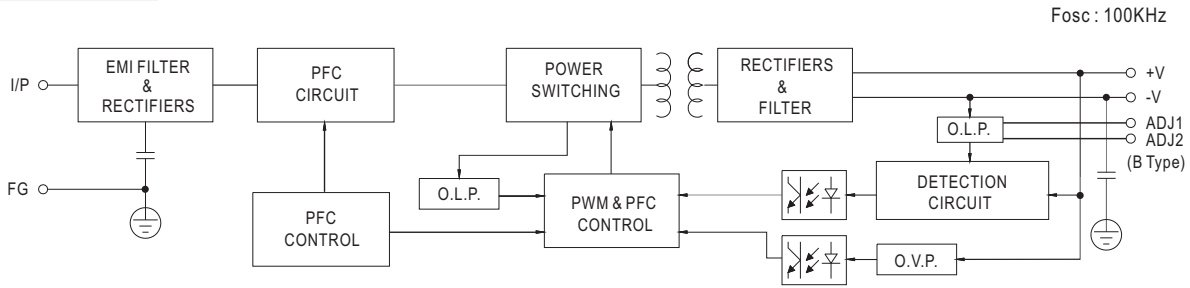

■ Derating Curve

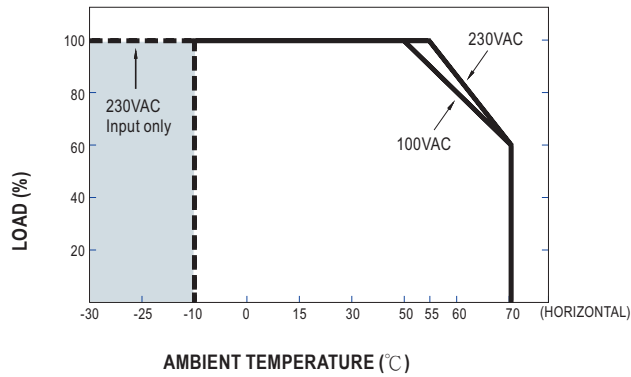

■ Static Characteristics

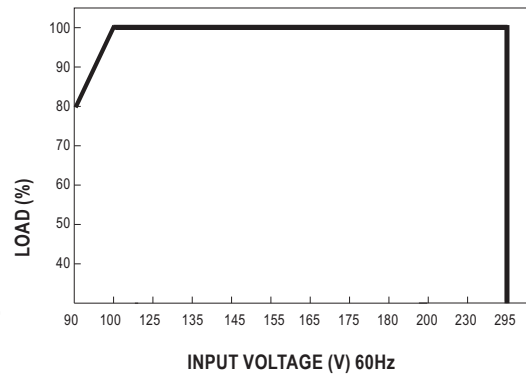

Power Factor Characteristic

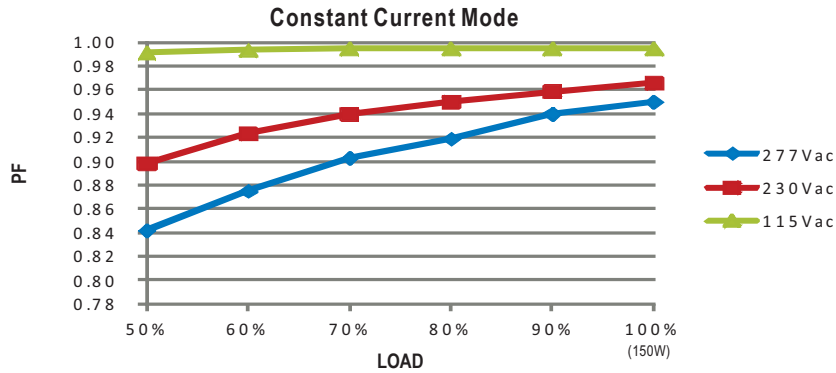

EFFICIENCY vs LOAD (48V Model)

CLG-150 series possess superior working efficiency that up to 91% can be reached in field applications.

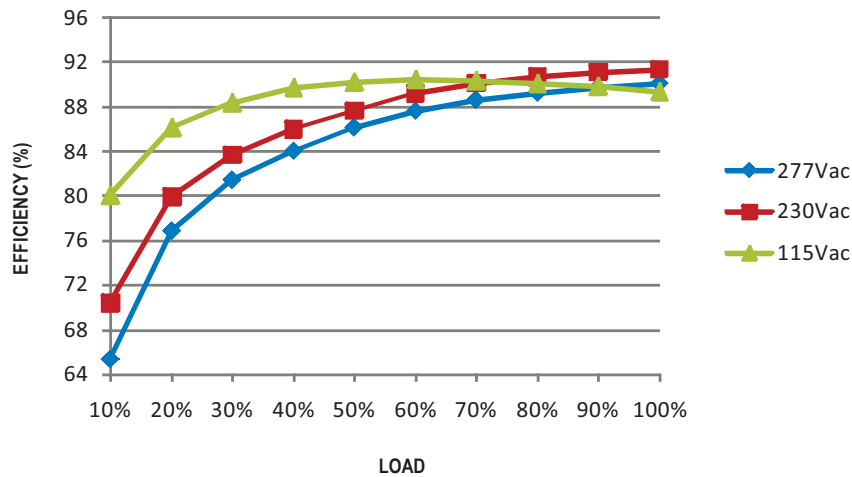

DRIVING METHODS OF LED MODULE

There are two major kinds of LED drive method "direct drive" and "with LED driver".

A typical LED power supply may either work in "constant voltage mode (CV) or constant current mode (CC)" to drive the LEDs.

Mean Well's LED power supply with CV+ CC characteristic can be operated at both CV mode [with LED driver, at area (A)] and CC mode [direct drive, at area (B)].

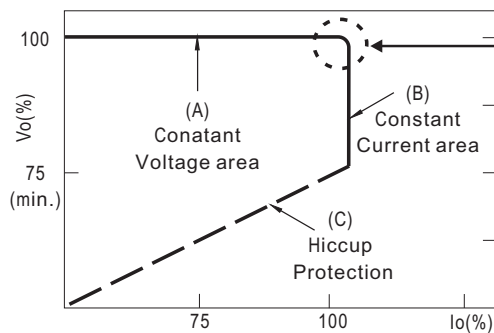

Typical LED power supply I-V curve

In the constant current region, the highest voltage at the output of the driver depends on the configuration of the end systems.

Should there be any compatibility issues, please contact MEAN WELL.