



## Index



|                                 |   |
|---------------------------------|---|
| AVAILABLE COLORS                | 1 |
| PRODUCT CODES & CHARACTERISTICS | 2 |
| BENDING RADIUS                  | 2 |
| POWER & CONNECTION DIAGRAM      | 3 |
| POWER SUPPLY CONSUMPTION        | 3 |
| CABLE SELECTION                 | 4 |
| SYMBOLS & DISCLAIMER            | 5 |

## Side RGB 160/240

The OrgaLED® Side RGB LED strip (IP40) is a high quality, flexible LED strip with a unique co-extrusion technology. The combination of high quality and exceptional flexibility, allows for an endless range of indoor and outdoor applications. Combine with either the IP67 or IP68 solution.

For the latest version of this datasheet, visit our website:  
[www.organiclighting.com](http://www.organiclighting.com)

## Available Colors

-  OrgaLED® RGB 160
-  OrgaLED® RGB 240

## Features

- Made in USA/EU
- Unique co-extrusion technology with built in reflector (hollow chamber)
- UV, frost, seawater & chlorine vapor resistant
- IP40 (IP68 with OrgaLED® Side Mirror Welded Connector)
- Very flexible (bend radius > 1.2")
- Dimmable
- Effective heat dissipation
- Excellent lumen/ Watt ratio
- Binning ± 50K
- Available in long lengths
- Extensive range of accessories
- Plug & Play



## Product Codes & Characteristics

|  | Side RGB 160<br>Deco                     | Side RGB 240<br>Power              |
|--|--|------------------------------------|
| Product code   | 011760                                   | 011597                             |
| Power (24 V DC)  | 1.46 W/ft                                | 2.26 W/ft                          |
| - Red  | 0.61 W/ft                                | 0.82 W/ft                          |
| - Green  | 0.61 W/ft                                | 0.88 W/ft                          |
| - Blue   | 0.24 W/ft                                | 0.61 W/ft                          |
| Power (25 V DC)  | 1.52 W/ft                                | 2.35W/ft                           |
| CRI  | > 80                                     |                                    |
| Luminous flux  | 29.5 lm/ft (R-10, G-18.9, B-2.4)         | 51.2 lm/ft (R-16.7, G-33.5, B-5.4) |
| Luminous efficiency  | 20 lm/W                                  | 23 lm/W                            |
| Spool length   | Max. 164 ft                              |                                    |
| Section length   | 7.87 in                                  |                                    |
| LED  | MULTILED                                 |                                    |
| Number of LEDs   | 7 per section / 10.67 per ft             |                                    |
| Max. connection length   | 32.8 ft                                  | 16.4 ft                            |
| Operation voltage  | 24 V DC                                  |                                    |
| Max. operation voltage   | 25 V DC                                  |                                    |
| Beam angle   | 110°                                     |                                    |
| Dimensions   | 0.47 x 0.47 in                           |                                    |
| Dimmable   | PWM dimming, 0-10V dimming               |                                    |
| Binning  | ± 50K (single bin)                       |                                    |
| Weight   | 1.6 oz/ft                                |                                    |
| Expected lifetime  | B50/L70 > 50,000 hours @ 104 °F          |                                    |
| Degree of protection (IP)  | IP40 (IP68 with mirror welded connector) |                                    |
| Storage temperature  | -22 °F - 185 °F                          |                                    |
| Operation temperature  | -22 °F - 131 °F                          |                                    |
| Minimal bending radius   | 1.2 in                                   |                                    |
| Max. connection length between 4 °F and -22 °F is 23 ft (RGB 160) and 11.5ft (RGB 240) |  |                                    |

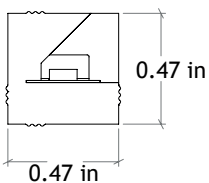

## Bending Radius

Maximum bending radius is 1.2 in. Solely bend up or downward. Do not compress, stretch or bend the LED strip.

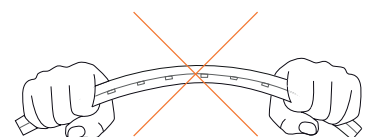
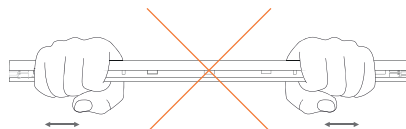
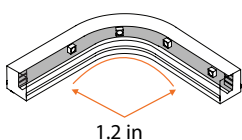

## Power & Connection Diagram

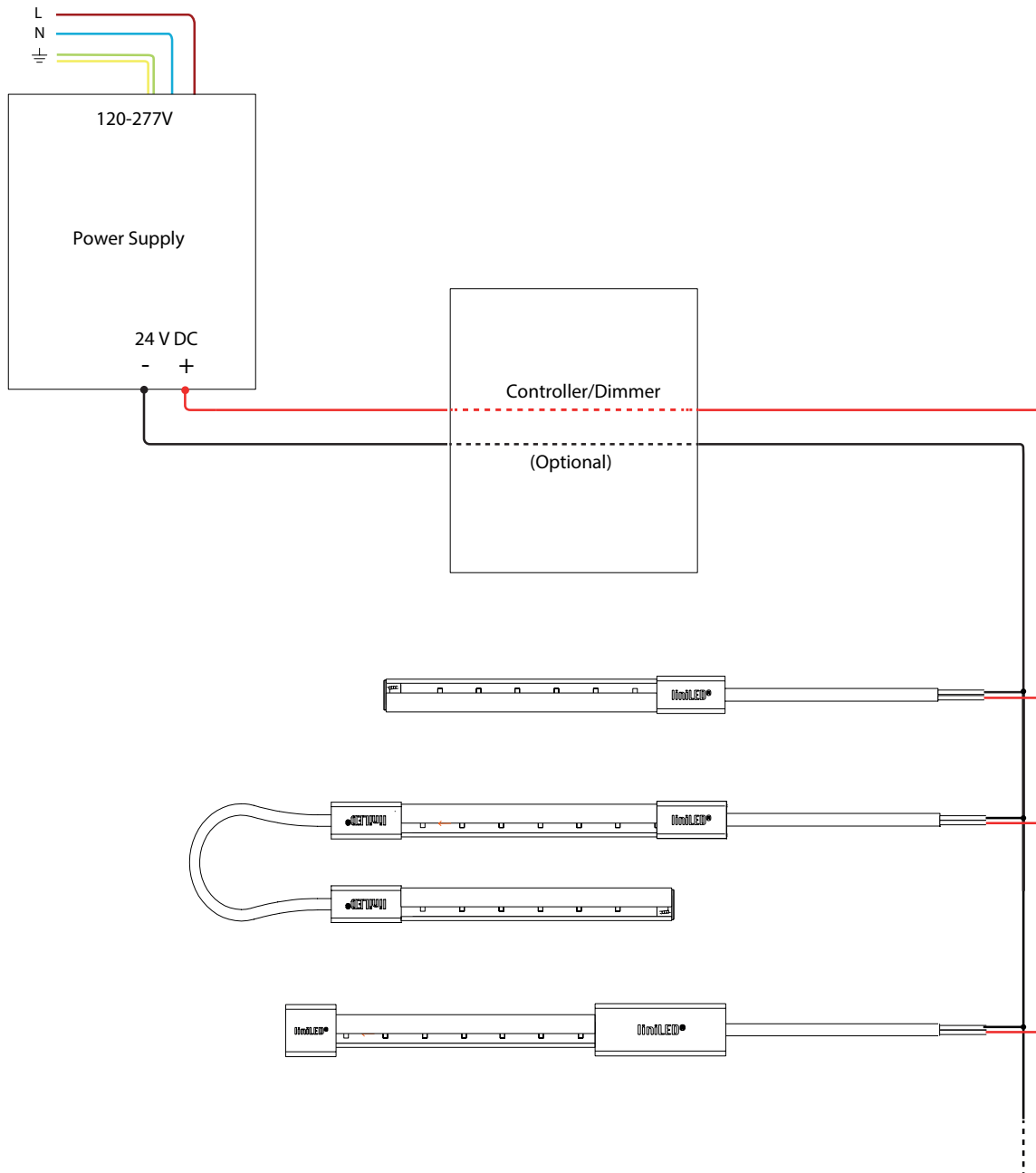

## Power Supply - 24V DC

To calculate the power consumption of a single length of LED strip, use the equation below.

$$P_{STRIP} = W_{WATTS} \times X_{LENGTH} \times 110\%$$

- $P_{STRIP}$  Calculated power consumption of one LED strip in Watt
- $W_{WATTS}$  Typical power consumption in Watt per foot of the selected LED strip  
This value can be found under 'Product characteristics' on page 2
- $X_{LENGTH}$  Length of the connected LED strip in feet
- 110% Safety margin to buffer differences over all production batches

## Cable Selection

The OrgaLED® LED strips need a minimum voltage at the beginning of the LED strip to function according to the specifications. The table below gives an indication of the maximum cable length based on the cable thickness and power supply voltage. The connection between the cable and LED strip is with a cable length of 3.28 ft.

In case the required length is larger than the length mentioned in this table, the supply voltage is different or if a detailed wire plan with branches is planned, please contact your distributor for a detailed cable calculation.

| Wire Gauge        | LED strip | Max. <b>cable x</b> length RGB 160 |            | Max. <b>cable x</b> length RGB 240 |            |
|-------------------|-----------|------------------------------------|------------|------------------------------------|------------|
|                   |           | @ 24 V DC                          | @ 25V DC   | @ 24 V DC                          | @ 25V DC   |
| <b>20 AWG x 2</b> | 3.28 ft   | 206.05 ft                          | 399.27 ft  | 134.55 ft                          | 262.01 ft  |
|                   | 6.56 ft   | 101.06 ft                          | 197.67 ft  | 65.3 ft                            | 129.04 ft  |
|                   | 16.4 ft   | 38.08 ft                           | 76.72 ft   | 23.75 ft                           | 49.23 ft   |
|                   | 32.8 ft   | 17.06 ft                           | 36.38 ft   | -                                  | -          |
| <b>18 AWG x 2</b> | 3.28 ft   | 441.29 ft                          | 855.06 ft  | 282.97 ft                          | 550.91 ft  |
|                   | 6.56 ft   | 141.5 ft                           | 279.42 ft  | 88.79 ft                           | 178.1 ft   |
|                   | 16.4 ft   | 81.51 ft                           | 164.26 ft  | 49.95 ft                           | 103.55 ft  |
|                   | 32.8 ft   | 36.54 ft                           | 77.93 ft   | -                                  | -          |
| <b>16 AWG x 2</b> | 3.28 ft   | 882.62 ft                          | 1710.16 ft | 565.93 ft                          | 1160.96 ft |
|                   | 6.56 ft   | 432.89 ft                          | 846.67 ft  | 274.67 ft                          | 542.64 ft  |
|                   | 16.4 ft   | 163.05 ft                          | 328.56 ft  | 99.91 ft                           | 207.1ft    |
|                   | 32.8 ft   | 73.11 ft                           | 155.87 ft  | -                                  | -          |
| <b>14 AWG x 2</b> | 3.28 ft   | 1468.95 ft                         | 2846.22 ft | 941.85 ft                          | 1833.82 ft |
|                   | 6.56 ft   | 720.45 ft                          | 1409.09 ft | 457.13 ft                          | 903.08 ft  |
|                   | 16.4 ft   | 271.35 ft                          | 546.81 ft  | 166.26 ft                          | 344.66 ft  |
|                   | 32.8 ft   | 121.66 ft                          | 259.38 ft  | -                                  | -          |

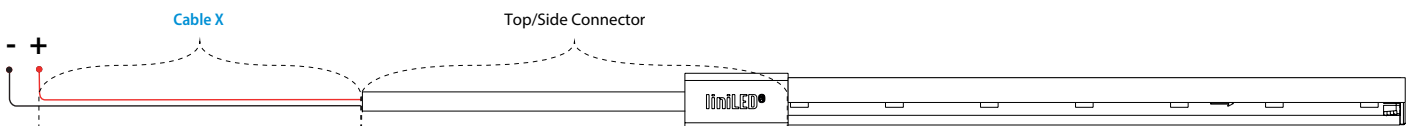

## Symbols

- 

UL is a world leader in product safety testing and certification. UL sets standards and tests products to make sure they meet standards.
- 

The ETL Listed mark indicates that your product has been tested by Intertek and found in compliance with accepted UL standards.
- 

Electro Static Discharge (ESD) sensitive device, apply standard ESD precautions when handling the product.
- 

Manufacturer's declaration that the product meets the applicable EC directives.
- 

Suitable for mounting on all surfaces and suitable to cover with insulating material.
- 

Restriction of Hazardous Substances (RoHS): product complies with the RoHS directive and each homogeneous material does not exceed the limits for the materials mentioned under the RoHS directive (Pb, Hg, Cd, Cr6+, PBB and PBDE).
- 

This product can be both IP40 and IP68 depending on the configuration and application. See the documentation for the exact IP rating.
- 

Bending of the LED strip is possible with a radius of  $\geq 1.2$  inches in the specified direction.
- 

Electrical appliance class III: this product is designed to be supplied from an extra-low voltage ( $\leq 60.0$  V DC or  $\leq 42.4$  V AC).
- 

System guarantee of 5 years when the complete system consist of OrgaLED® products with the 5 year system warranty logo.
- 

Product is resistant against ultraviolet (UV) light or sunlight. Non-UV resistant products can degrade or discolor fast when exposed to UV.
- 

Product can be cleaned with normal cleaning agents as specified in the datasheet under 'chemical compliances.'
- 

This product can be stored and used below 32 degrees Fahrenheit. Verify the minimum storage and operation temperature in the datasheet for the lowest temperature allowed.
- 

This product can be applied in seawater and its environment. Elements in seawater will have no harmful effect on the product. For chemical specifications see datasheet. Verify the IP rating for proper use.
- 

This product can be applied inside swimming pool environments. Elements in the air will have no harmful effect on the product. For chemical specifications of these elements see datasheet. Verify the IP rating for proper use.
- 

This product is available on request and can be submerged n swimming pools and their environments. Disinfectants will have no harmful effect on product. For chemical specifications of these elements see datasheet. Verify the IP rating for proper use.
- 

The CRI value of this product is 80 or higher.
- 

The binning tolerance of this product is 2 MacAdam.

## Disclaimer

The published information is checked to be as accurate as possible, however Organic Lighting, or any reseller of OrgaLED® cannot be held liable for any damages resulting from errors or outdated information. Organic Lighting reserves the right to modify the information without informing the costumers. When this document is printed or downloaded, please check for the latest version on the internet, the most up to date information will be published on [www.organiclighting.com](http://www.organiclighting.com). This product should not be used in applications, devices or systems where incorrect operation of the product may result in personal injury (includes emergency lighting) without written permission from the board of Organic Lighting. If nevertheless used in such applications, devices or systems Organic Lighting cannot be held liable for any resulting injury.