

Step 1: Scale: 6" = 1'-0"

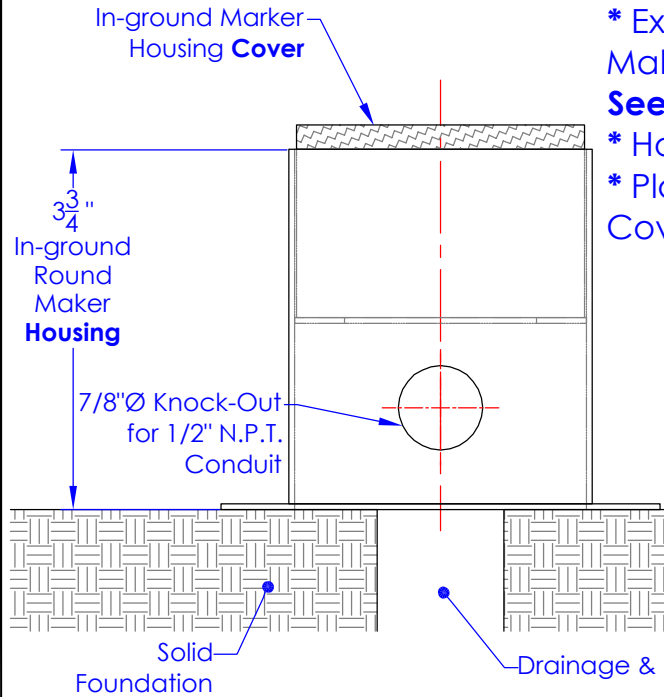

- * Excavate soil for "In-ground Maker Housing" and conduit Run. **See Detail A.**
- * Housing to sit on Solid Foundation.
- * Place "In-ground Maker Housing Cover" on housing.

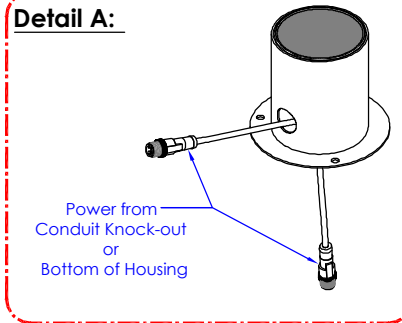

Step 3: Scale: N.T.S.

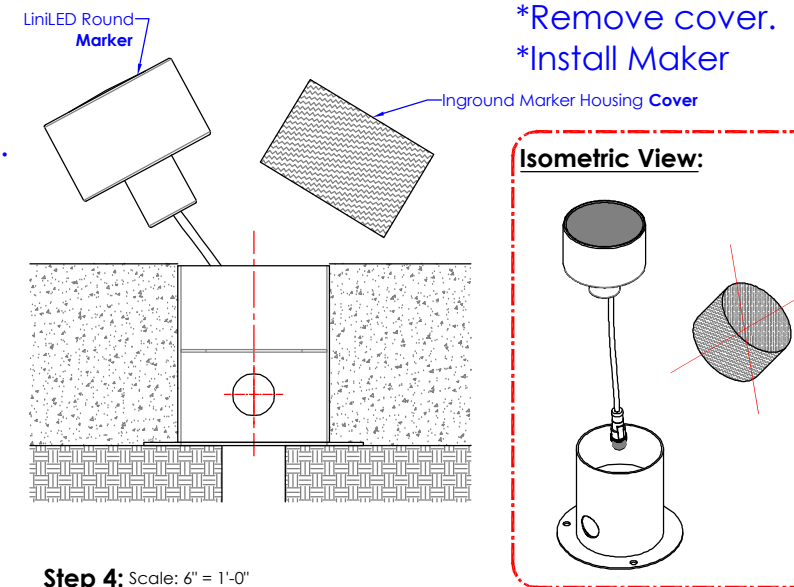

- *Remove cover.
- *Install Maker

Step 2: Scale: 6" = 1'-0"

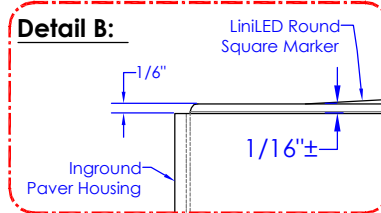
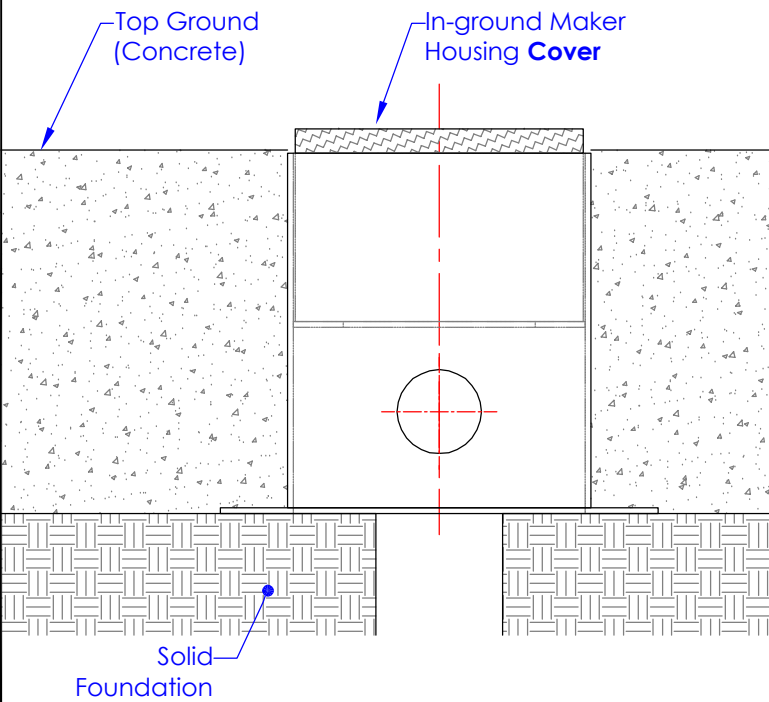

- *Surround "Housing" by Top Ground.
- *Level Top Ground appropriately.
- Note: Marker to project from Housing approximately 1/16".
- See Detail B.**
- *Cover to prevent any debris from entering housing.

Step 4: Scale: 6" = 1'-0"

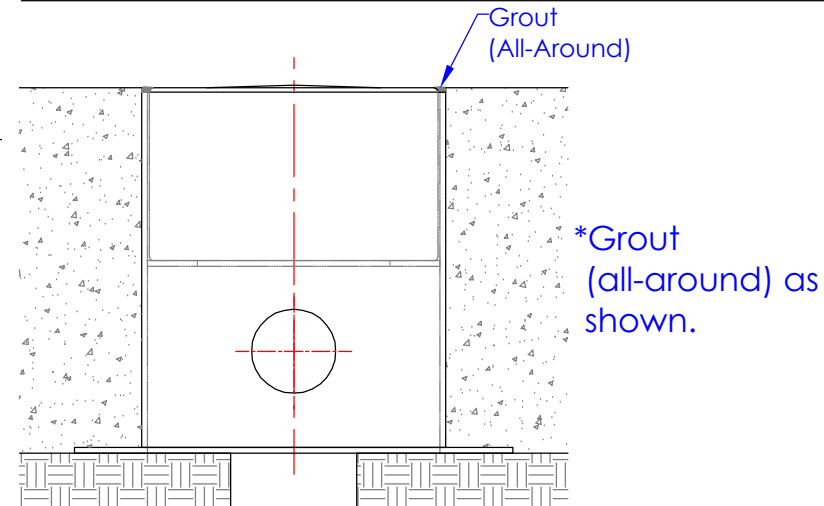

	NAME	DATE
DRAWN BY:	EO	03/04/15
CHECKED	-	-
ENG REVISION:		
MATERIAL:		
FINISH:		
UNLESS OTHERWISE SPECIFIED:		
DIMENSIONS ARE IN INCHES		
TOLERANCES:		
FRACTIONAL ± 1/16		
ANGULAR: MACH ±0.5 BEND ± 0.03		
TWO PLACE DECIMAL ±.030		
THREE PLACE DECIMAL ±.015		
ORDER #	-	

ORGANIC LIGHTING SYSTEMS

511 N. Virginia Ave.
Azusa, Ca. 91702. USA
Ph: 626.969.6820 Fax: 626.696.6830 Web: organiclighting.com

TITLE:
Round Marker & Housing Installation

SIZE	DWG. NO.	REV
A	-	

Step 1: Scale: 6" = 1'-0"

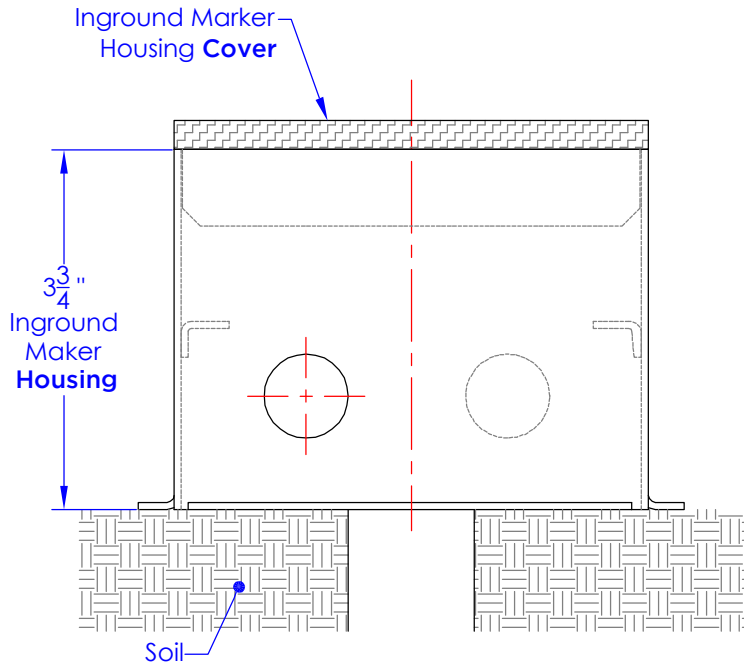

- * Excavate soil for "Inground Maker Housing" and conduit Runs.
- * Place "Inground Maker Housing Cover" on housing.

REVISION			
REV.	DESCRIPTION	DATE	DRAWN BY

Step 3: Scale: 6" = 1'-0"

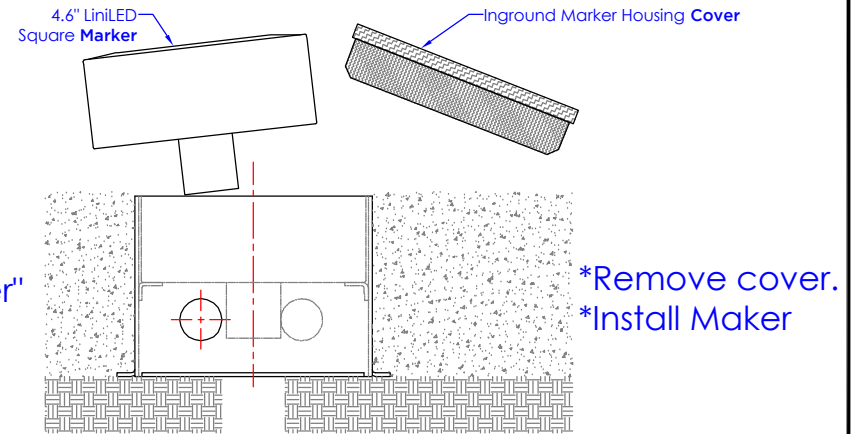

Step 4: Scale: 6" = 1'-0"

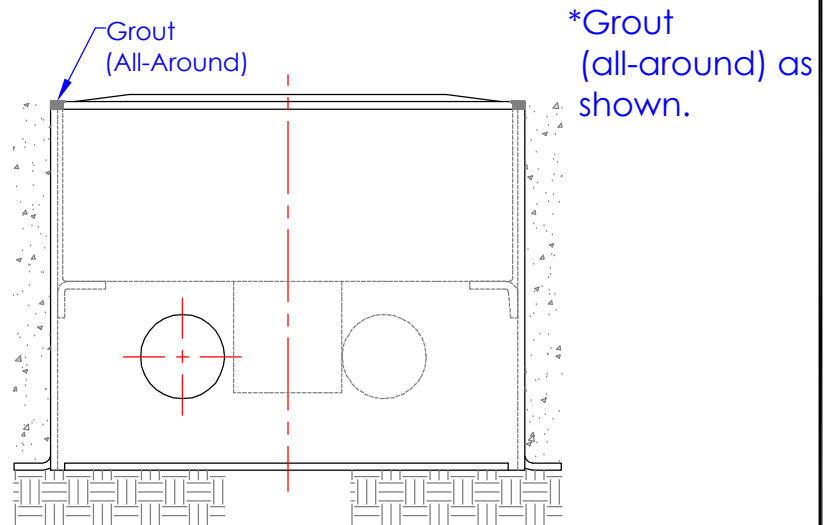

Step 2: Scale: 6" = 1'-0"

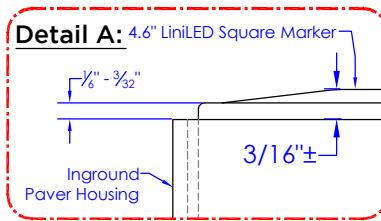
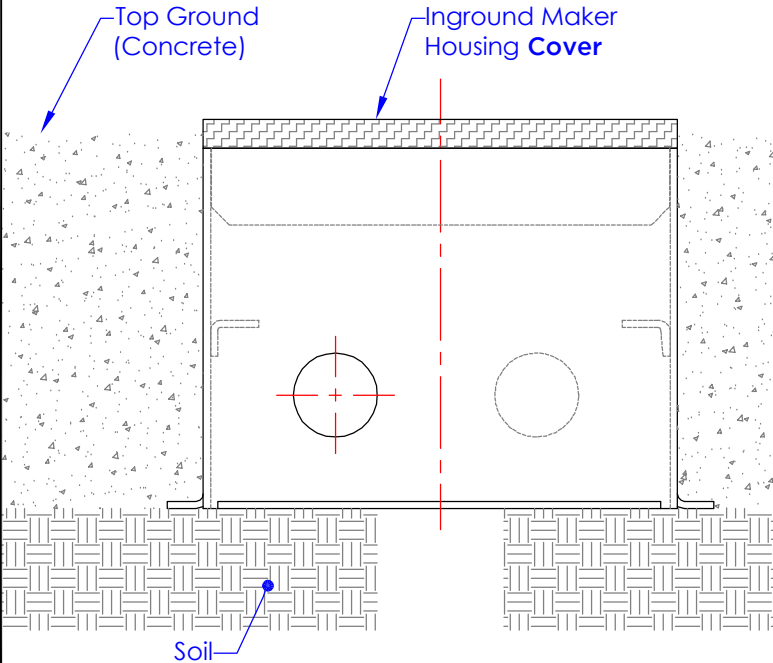

- * Surround "Housing" by Top Ground.
- * Level Top Ground appropriately.
- Note: Marker to project from Housing approximately 3/16".
- See Detail A**
- * Cover to prevent any debris from entering housing.

	NAME	DATE
DRAWN BY:	EO	07/08/14
CHECKED:	-	-
ENG REVISION:		
MATERIAL:		
FINISH:		
UNLESS OTHERWISE SPECIFIED:		
DIMENSIONS ARE IN INCHES		
TOLERANCES:		
FRACTIONAL ± 1/16		
ANGULAR: MACH ± 0.5 BEND ± 0.03		
TWO PLACE DECIMAL ± 0.03		
THREE PLACE DECIMAL ± 0.015		
ORDER #	-	

ORGANIC LIGHTING SYSTEMS

511 N. Virginia Ave.
Azusa, Ca. 91702. USA
Ph: 626.969.6820 Fax: 626.696.6830 Web: organiclighting.com

TITLE:
Square Marker & Housing Installation

SIZE	DWG. NO.	REV
A	-	